



**SILENT
KNIGHT**

by Honeywell

MODEL IFP-100

Analog/Addressable Fire Control Panel

**Installation and
Operations Manual**

Part Number 151280 Rev L

Installation Procedure

Adherence to the following will aid in problem-free installation with long-term reliability:

Installation Precautions - Adherence to the following will aid in problem-free installation with long-term reliability: **WARNING** - Several different sources of power can be connected to the fire alarm control panel. Disconnect all sources of power before servicing. Control unit and associated equipment may be damaged by removing and/or inserting cards, modules, or interconnecting cables while the unit is energized. Do not attempt to install, service, or operate this unit until manuals are read and understood. **CAUTION** - System Re-acceptance Test after Software Changes: To ensure proper system operation, this product must be tested in accordance with NFPA 72 after any programming operation or change in site-specific software. Re-acceptance testing is required after any change, addition or deletion of system components, or after any modification, repair or adjustment to system hardware or wiring. All components, circuits, system operations, or software functions known to be affected by a change must be 100% tested. In addition, to ensure that other operations are not inadvertently affected, at least 10% of initiating devices that are not directly affected by the change, up to a maximum of 50 devices, must also be tested and proper system operation verified. This system meets NFPA requirements for operation within the range of 0°C-49°C (32°F-120°F) or humidity within the range of 10%-93% at 30°C (86°F) noncondensing. However, the useful life of the system's standby batteries and the electronic components may be adversely affected by extreme temperature ranges and humidity. Therefore, it is recommended that this system and its peripherals be installed in an environment with a normal room temperature of 15-27° C/60-80° F. **Verify that wire sizes are adequate** for all initiating and indicating device loops. Most devices cannot tolerate more than a 10% I.R. drop from the specified device voltage. **Like all solid state electronic devices**, this system may operate erratically or can be damaged when subjected to lightning induced transients. Although no system is completely immune from lightning transients and interference, proper grounding will reduce susceptibility. Overhead or outside aerial wiring is not recommended, due to an increased susceptibility to nearby lightning strikes. Consult with the Technical Services Department if any problems are anticipated or encountered. **Disconnect AC power and batteries** prior to removing or inserting circuit boards. Failure to do so can damage circuits. Remove all electronic assemblies prior to any drilling, filing, reaming, or punching of the enclosure. When possible, make all cable entries from the sides or rear. Before making modifications, verify that they will not interfere with battery, transformer, or printed circuit board location. **Do not tighten screw terminals** more than 9 in-lbs. Over-tightening may damage threads, resulting in reduced terminal contact pressure and difficulty with screw terminal removal. Silent Knight fire alarm control panels contain static-sensitive components. Always ground yourself with a proper wrist strap before handling any circuits so that static charges are removed from the body. Use static suppressive packaging to protect electronic assemblies removed from the unit.

Follow the instructions in the installation, operating, and programming manuals. These instructions must be followed to avoid damage to the control panel and associated equipment. FACP operation and reliability depend upon proper installation.

While installing a fire alarm system may make lower insurance rates possible, it is not a substitute for fire insurance! **An automatic fire alarm system** - typically made up of smoke detectors, heat detectors, manual pull stations, audible warning devices, and a fire alarm control with remote notification capability - can provide early warning of a developing fire. Such a system, however, does not assure protection against property damage or loss of life resulting from a fire. **Any fire alarm system** may fail for a variety of reasons: Smoke detectors may not sense fire where smoke cannot reach the detectors such as in chimneys, in walls, or roofs, or on the other side of closed doors. **Smoke detectors** also may not sense a fire on another level or floor of a building. A second floor detector, for example, may not sense a first floor or basement fire. Furthermore, all types of smoke detectors, including ionization and photoelectric types, have sensing limitations. No type of smoke detector can sense every kind of fire caused by carelessness and safety hazards like smoking in bed, violent explosions, escaping gas, improper storage of flammable materials, overloaded electrical circuits, children playing with matches, or arson.

IMPORTANT! Smoke detectors must be installed in the same room as the control panel and in rooms used by the system for the connection of alarm transmission wiring, communications, signaling, and/or power. If detectors are not so located, a developing fire may damage the alarm system, crippling its ability to report a fire. **Audible warning devices** such as bells may not alert people if these devices are located on the other side of closed or partly open doors or are located on another floor of a building. **A fire alarm system** will not operate without any electrical power. If AC power fails, the system will operate from standby batteries only for a specified time. **Rate-of-Rise heat detectors** may be subject to reduced sensitivity over time. For this reason, the rate-of-rise feature of each detector should be tested at least once per year by a qualified fire protection specialist. **Equipment used in the system** may not be technically compatible with the control. It is essential to use only equipment listed for service with your control panel. **Telephone lines** needed to transmit alarm signals from a premise to a central monitoring station may be out of service or temporarily disabled. **The most common cause** of fire alarm malfunctions, however, is inadequate maintenance. All devices and system wiring should be tested and maintained by professional fire alarm installers following written procedures supplied with each device. System inspection and testing should be scheduled monthly or as required by National and/or local fire codes. Adequate written records of all inspections should be kept.

Contents

Section 1

Introduction 1-1

- 1.1 Overview of Basic System 1-1
 - 1.1.1 Hardware Features 1-1
 - 1.1.2 Software Features 1-2
- 1.2 About this Manual 1-2
 - 1.2.1 Terms Used in this Manual 1-2
- 1.3 Compatible Products 1-3
- 1.4 How to Contact Silent Knight 1-4
 - Limitations of Fire Alarm Systems 1-5
 - Requirements and recommendations for proper use of fire alarm systems including smoke detectors and other fire alarm devices: 1-7

Section 2

Agency Listings, Approvals, and Requirements 2-1

- 2.1 Federal Communications Commission (FCC) 2-1
- 2.2 Underwriters Laboratories (UL) 2-3
 - 2.2.1 Requirements for All Installations 2-3
 - Restricted Options: 2-3
 - 2.2.2 Requirements for Central Station Fire Alarm Systems 2-3
 - 2.2.3 Requirements for Local Protected Fire Alarm Systems 2-4
 - 2.2.4 Requirements for Remote Station Protected Fire Alarm Systems 2-4
 - 2.2.5 Requirements for Auxiliary Protected Fire Alarm Systems for Fire Alarm Service 2-4

Section 3

Before You Begin Installing 3-1

- 3.1 What's in the Box? 3-1
- 3.2 Environmental Specifications 3-1
- 3.3 Electrical Specifications 3-2
- 3.4 Wiring Specifications 3-3
- 3.5 Board Assembly Diagram 3-4
- 3.6 Calculating Current Draw and Standby Battery 3-5
 - 3.6.1 Current Draw Worksheet Requirements 3-5
 - 3.6.1.1 Current Draw Worksheet for IDP SLC Devices 3-6
 - 3.6.1.2 Current Draw Worksheet Hochiki for SLC Devices 3-9
 - 3.6.1.3 Maximum Battery Standby Load 3-11

Section 4

Control Panel Installation 4-1

4.1	Mounting the Control Panel Cabinet	4-1
4.1.1	Preventing Water Damage	4-1
4.1.2	Removing the IFP-100 Assembly from the Housing	4-1
4.2	AC Connection	4-2
4.3	Battery Connection	4-3
4.3.1	RBB Accessory Cabinet	4-4
4.3.1.1	Installing the RBB Accessory Cabinet and Batteries	4-4
4.4	SBUS Wiring	4-6
4.4.1	Calculating Wiring distance for SBUS modules	4-6
	Wiring Distance calculation example:	4-8
4.4.2	Wiring Configurations	4-8
4.5	RA-100 Remote Annunciator Installation	4-9
4.5.1	Mounting the RA-100	4-10
4.5.1.1	Flush Mounting	4-10
4.5.1.2	Surface Mounting	4-12
4.6	RA-1000 Remote Annunciator Installation	4-13
4.6.1	Mounting the RA-1000	4-14
4.6.1.1	Flush Mounting	4-15
	Flush Mounting with an Electrical Box	4-16
	Flush Mounting Steps	4-16
4.6.1.2	Surface Mounting	4-17
4.6.2	Connecting the RA-1000 to the Panel	4-18
4.7	5824 Serial/Parallel Printer Interface Module Installation	4-18
4.7.1	Selecting 5824 Options	4-20
	Printer and Output Port Options	4-20
4.8	5880 LED I/O Module	4-21
4.8.1	5880 Board Layout	4-21
4.8.2	FACP Connection	4-22
4.8.3	LED Wiring	4-23
4.8.4	Dry Contact Wiring	4-24
4.9	5865-3 / 5865-4 LED Annunciator Installation	4-25
4.9.1	FACP Connection	4-25
4.9.2	5865 Mounting	4-26
4.10	Configuring Modules	4-27
4.10.1	Assigning Module IDs	4-27
4.11	Telephone Connection	4-28
4.12	5211 Ground Start Relay	4-28
4.13	Notification Appliance/Auxiliary Power Circuits	4-28
4.13.1	Conventional Notification Appliance	4-29
4.13.1.1	Class B Notification Wiring	4-29
4.13.1.2	Class A Notification Wiring	4-30
4.13.2	Auxiliary Power Installation	4-31
4.13.2.1	Door Holder Power	4-31
4.13.2.2	Constant Power	4-32
4.13.2.3	Resettable Power	4-32
4.14	On-Board Programmable Relays (Conventional)	4-32
4.14.1	Trouble Relay	4-32
4.14.2	Programmable Relays	4-32

4.15 Remote Station Applications	4-33
4.15.1 Keltron Model 3158 Installation	4-33
4.15.2 City Box Connection Using the 5220 Module	4-34
4.15.3 NFPA 72 Polarity Reversal	4-35
4.15.3.1 Using the 5220 Module	4-35
4.15.3.2 Using the 7644 Module	4-37
4.15.4 Using the SD500-ARM Addressable Relay Module	4-38
4.15.5 Using a MR-201/T Control Relay From Air Products	4-39
4.15.6 Transmitter Activated by Dry Contacts	4-40

Section 5

IDP and Hochiki SLC Device Installation 5-1

5.1 List of IDP SLC Devices	5-1
5.2 List of Hochiki SLC Devices	5-2
5.3 Maximum Number of Devices	5-3
5.4 Wiring Requirements for SLC Devices	5-3
5.4.1 Wiring 5815XL in Style 4 (Class B) Configuration	5-3
5.4.2 Wiring 5815XL in Style 6 & 7 (Class A) Configuration	5-5
5.5 Wiring IDP SLC Detectors	5-6
5.6 Addressing IDP SLC Devices	5-6
5.7 Wiring Hochiki Detectors	5-8
5.8 Addressing Hochiki Devices	5-9
5.8.1 SD505-APS, SD505-AHS, & SD505-AIS	5-9
5.8.2 Hochiki SLC Devices with Dip Switches	5-10

Section 6

Programming Overview 6-1

6.1 JumpStart Autoprogramming	6-1
6.1.1 Input Points	6-2
6.1.2 Output Points	6-2
6.1.3 Running JumpStart	6-2
6.2 Mapping Overview	6-4
6.2.1 Input Point Mapping	6-5
6.2.2 Output Circuit Mapping	6-6
6.2.3 Zone Event Mapping	6-7
6.2.4 Mapping LED Points	6-9
6.3 Programming Using the 5650/5651 Silent Knight Software Suite	6-10
6.4 Programming Using an Annunciator	6-10
6.4.1 Entering / Exiting the Programming Menu	6-11
6.4.2 Moving through the Menus	6-11
6.4.3 Selecting Options and Entering Data	6-12
6.4.4 Editing Keys	6-12
6.5 Programming Menu Quick Reference	6-13

Section 7

Programming 7-1

7.1	UL 864 Programming Requirements	7-1
7.2	SLC Family	7-2
7.3	Modules	7-2
7.3.1	Edit Modules	7-2
7.3.1.1	Naming Modules	7-3
7.3.1.2	Module, Wiring Class	7-3
7.3.2	Adding a Module	7-3
7.3.3	Deleting a Module	7-4
7.4	Zone	7-4
7.4.1	Edit Zone	7-4
7.4.1.1	Edit Zone Name	7-5
7.4.1.2	Edit Zone Properties	7-6
	Alarm Delay Characteristics	7-7
	Heat Detector Sensitivity	7-9
	Smoke Detector Sensitivity	7-9
7.4.1.3	Zone Outputs	7-10
	Zone Mapping to Voice Output Groups	7-10
	Mapping to Zone Events	7-11
	Zone Mapping Example	7-12
7.4.1.4	Cadence Patterns	7-13
7.4.1.5	Zone Accessory Options	7-13
7.4.2	Add Zone	7-14
7.4.3	Delete Zone	7-14
7.4.4	View Zone Points	7-16
7.5	Group	7-17
7.5.1	Edit Group	7-17
7.5.1.1	Edit Group Name	7-18
7.5.1.2	Edit Group Properties	7-18
	Latching / Non-latching Outputs	7-19
	Silencing Options	7-19
	Response with System-Wide Conditions	7-19
	Define Output Group Type	7-21
7.5.2	Add Group	7-21
7.5.3	Delete Group	7-22
7.5.4	View Group Points	7-23
7.5.5	Edit Output Group Templates	7-23
7.6	Point	7-24
7.6.1	Point Programming for the SLC	7-24
7.6.2	Point Programming For Internal or External Power Module (5496)	7-28
7.6.3	Point Programming For 5880, 5865, VIP-50, and VIP-CE4 Modules	7-29
7.6.3.1	Assigning a Name to a Point	7-30
7.7	System Options	7-31
7.7.1	Reporting Account	7-31
7.7.1.1	Edit Accounts	7-32
	Select Account (ID)	7-32
	Edit Account Number	7-32
	Select Reporting Format	7-32
	Events to Report	7-34
	Switch Attempts	7-34
	Telephone Number	7-35
7.7.1.2	Auto Test Time	7-35

7.7.2	Phone Lines	7-36
7.7.2.1	Dialing Prefix	7-36
7.7.2.2	Number of Answer Rings	7-37
7.7.2.3	Dial Option (TouchTone or Pulse)	7-37
7.7.2.4	Rotary Format	7-37
7.7.2.5	Line Monitor	7-37
7.7.2.6	Ground Start Relay	7-38
7.7.2.7	Answering Machine Bypass	7-38
7.7.3	Sys. Event Outputs	7-39
7.7.3.1	Trouble Events	7-40
7.7.3.2	System Alarm Cadence	7-41
7.7.4	Day/Night Sensitivity Time	7-42
7.7.5	Holiday Days	7-43
7.7.6	Miscellaneous Options 1	7-44
7.7.6.1	Water Flow Delay	7-44
7.7.6.2	Low AC Report Delay	7-44
7.7.6.3	Automatic Daylight Saving Time Adjustment	7-45
7.7.6.4	Clock Display Format (AM/PM or Military)	7-45
7.7.6.5	Change AC Line Frequency	7-45
7.7.7	Miscellaneous Options 2	7-46
7.7.7.1	Synchronize Strobes Active During Silence	7-46
7.7.7.2	Auto Display Oldest Event	7-46
7.7.7.3	Report by Zone or by Point	7-46
7.7.8	Miscellaneous Options 3	7-47
7.7.8.1	Alarm Verification Time	7-47
7.7.8.2	Daylight Saving Time Start and End	7-47
7.7.9	Edit Banner Message	7-49
7.7.10	Edit Voice Commands	7-50
7.8	JumpStart Autoprogramming	7-51
7.9	Computer Account	7-51
7.10	Access Codes	7-53
7.10.1	Profile Edit Menu	7-55
7.10.1.1	Edit Name	7-55
7.10.1.2	Edit Access Code	7-55
7.10.1.3	Panel Functions	7-55
7.11	VIP-VCM Maintenance	7-56
7.11.1	PC Connection	7-56
7.11.2	Local Recording	7-56

Section 8

System Operation 8-1

8.1	Default User and Installer Codes	8-1
8.2	Annunciator Description	8-1
8.2.1	LCD Displays	8-2
8.2.2	Banner	8-2
8.3	Menu System	8-3
8.3.1	Main Menu Overview	8-3
8.3.2	Using the Menus	8-4
8.4	Basic Operation	8-4
8.4.1	Setting Time and Date	8-4
8.4.2	Disable / Enable a Point	8-4
8.4.3	Disable / Enable NACs by Group	8-4
8.4.4	View Event History	8-5

8.4.5	Clear Event History	8-5
8.4.6	Conduct a Fire Drill	8-5
8.4.7	Conduct an Indicator Test	8-5
8.4.8	Conduct a Walk Test	8-6
8.4.9	Conduct a Dialer Test	8-6
8.4.10	Silence alarms or troubles	8-7
8.4.11	Reset alarms	8-7
8.4.12	Check Detector Through Point Status	8-7
8.4.13	View Status of a Point	8-8
8.4.14	View Alarms or Troubles	8-8
8.4.15	View System Information	8-8
8.4.16	Reset dialer	8-8
8.4.17	Communicating with a Remote Computer	8-9
8.4.18	Working with a Printer	8-10
8.5	Operation Mode Behavior	8-11
8.6	Releasing Operations	8-14
8.6.1	Single Interlock Zone Releasing	8-15
	Conditions Required for an Pre-Alert Output Activation	8-15
	Conditions required for an General Alarm and Release Output Activation	8-15
8.6.2	Double Interlock Zone Releasing	8-16
	Conditions Required for a Pre-Alert Output Activation	8-16
	Conditions Required for a General Alarm Output Activation	8-16
	Conditions Required for a Release Output Activation	8-16
8.7	Smoke Alarm Verification	8-17

Section 9

Reporting

9.1	Receivers Compatible with the Control Panel	9-1
9.2	Reporting Formats Dialer Outputs	9-1

Section 10

Testing and Troubleshooting

10.1	Troubleshooting	10-1
10.2	Common Problems	10-1
10.2.1	Event History	10-2
10.3	Built-in Troubleshooting and Testing Tools	10-3
10.3.1	SLC Device Locator	10-3
10.3.2	SLC Multi Locator	10-4
10.3.3	I/O Point Control	10-5
10.4	Impedances that Cause Earth Ground Faults	10-5

Section 11

Installation Records

11.1	Hochiki SLC Device Point Record	11-1
------	---------------------------------------	------

11.2 IDP SLC Device Point Record 11-3

Appendix A

Compatible Devices A-1

A.1 Two-Wire Smoke Detectors A-12

Appendix B

Special Characters ListsB-1

B.1 Characters used for NamingB-1

Silent Knight Fire Product Warranty and Return Policy

Model IFP-100 Basic Operating Instructions

Section 1

Introduction

The IFP-100 Fire Alarm Control / Communicator is an analog/addressable fire control system that meets the requirements of UL 864.

1.1 Overview of Basic System

The IFP-100 base system is an addressable system with a built-in annunciator that can also be used to program the system.

1.1.1 Hardware Features

- The IFP-100 has one signaling line circuit (SLC) that supports Intelligent Device Protocol (IDP) devices or Hochiki protocol devices.
- The control panel's SLC supports 99 IDP detectors and 99 IDP modules or 127 Hochiki protocol devices.
- 6.0A of output power is available through 4 sets of terminals for notification appliance circuits or auxiliary applications. Each circuit is power limited per UL 864 and can source up to 3.0A (total output power for all 6 circuits must not exceed 6.0A).
- Built-in dual phone line, digital alarm communicator/transmitter (DACT).
- Reports events to central station by point or by zone.
- UL Listed for pre-action and deluge releasing systems.
- Two general purpose Form C programmable relays.
- One Form C Trouble Relay.
- Can be used with up to 8 Model RA-100 or RA-1000 Remote Annunciators (sold separately).
- Can be used with Model 5865-3, 5865-4, and 5880 in any combination for a total of eight devices on one control panel. See Sections 4.8 and 4.9 for additional information on these models.
- Printing of detector status, event history, and real time event log available through the Model 5824 serial/parallel printer interface module (sold separately).
- 125 software zones, 125 output groups.
- Add 4 Notification/Auxiliary power circuits with each 5496 Intelligent Power Module (up to 8, 5496s per system).
- Add 6 Flexput circuits with each RPS-1000 Intelligent Power Module (up to 8, 5496s8 RPS-1000s per system).

Note: The system can have a maximum of eight Intelligent Power Modules, 5496 or RPS-1000, combined.

1.1.2 Software Features

- Advanced smoke detector features:
 - Automatic drift compensation
 - Automatic day/night sensitivity adjustment
 - Maintenance alert region
 - Point status eliminates calibrated smoke test requirements for NFPA 72
- “JumpStart” feature for easy programming
- Non-volatile event history stores 1000 events
- A choice of output patterns available for notification outputs, including ANSI 3.41 temporal signal
- Built-in synchronization appliance support for AMSECO, Faraday, Gentex[®], System Sensor[®], and Wheelock[®].

1.2 About this Manual

This manual is intended to be a complete reference for all installation and operation tasks for the IFP-100. Please let us know if the manual does not meet your needs in any way. We value your feedback!

1.2.1 Terms Used in this Manual

The following terminology is used with the IFP-100 system:

Term	Description
SLC	Signaling Line Circuit
Module	The term module is used for all hardware devices except for SLC addressable devices and notification appliances. This includes the IFP-100 panel itself.
Input Point	An addressable sensing device, such as a smoke or heat detector or a contact monitor device.
Input Zone	A protected area made up of input points.
Output Point (or Output Circuit)	A notification point or circuit for notification appliances. Relay circuits and auxiliary power circuits are also considered output points.
Group (or “Output Group”)	A group of output points. Operating characteristics are common to all output points in the group.
Output (or “Cadence”) Pattern	The pattern that the output will use, for example, Constant, March Code, ANSI 3.41. Applies to zones and special system events. See Section 7.7.3.2 for additional information.
Mapping	Mapping is the process of specifying which outputs are activated when certain events occur in the system. Section 6.2 explains mapping in detail.

1.3 Compatible Products

The chart below lists the products available from Silent Knight for use with the IFP-100.

Type of Device	Model	Description	
IDP Addressable SLC Devices	See Section 5.1 for a list of compatible devices.		
Hochiki Addressable SLC Devices	See Section 5.2 for a list of compatible devices.		
Other Modules	5211 Ground Start Relay	For use with ground start telephone network. (Do not use in UL installations.)	
	5824 Serial/Parallel Printer Interface Module	Allows a printer to be attached for the system for on-site event logging, detector status and event history reports. Two maximum per system.	
	RPS-1000 Intelligent Power Module	Provides additional power, six Flexput™ circuits, and two Form C relays. Max. 8 per system see <i>Model RPS-1000 Installation Instructions P/N 151024</i> .	RPS-1000s and 5496s can be used in any combination, up to a total of eight devices on one panel.
	5496 Intelligent Power Module	Add 4 Notification/Auxiliary power circuits with each 5496 Intelligent Power Module (up to 8, 5496s per system).	
	RA-100 Remote Alarm Annunciator	Same operation, and similar appearance to the on-board annunciator. up to 8 RA-100s per system. The RA-100 is red.	RA-100s and RA-1000s can be used in any combination, up to a total of eight devices on one panel.
	RA-1000 and RA-1000R Remote Alarm Annunciator	Remote Annunciator without a door access, requires a Fireman's key or access code to silence or reset.	
	5865-3 and 5865-4 LED Annunciator	LED annunciator can display up to 30 LEDs (15 red and 15 yellow). 5865-4 has key switches for silence and reset, and a system trouble LED.	5865-3, 5865-4, and 5880 can be used in any combination, up to a total of eight devices on one panel.
	5880 LED I/O Module	Driver for up to 40 LEDs. Interfaces with customized annunciator boards. In addition the 5880 has eight generic switch input points.	
	5883 General Purpose Relay Module	Provides 10 Form C relays. Designed to be driven by the 5880. Up to four, 5883s can be used with each 5880 module.	
	VIP-VCM	Voice Control Module used with the IFP-100VIP.	Refer to the <i>VIP-Series Installation Manual P/N 151286</i> for more information on these accessories.
	VIP-SW16	16 switch expander with the IFP-100VIP.	
	VIP-50	50 watt audio amplifier	
	VIP-CE4	Provides 4 additional audio circuits for the VIP-50	
VIP-RM	Remote Microphone used with the IFP-100VIP.		
Software	5650/5651 Silent Knight Software Suite (SKSS)	For communication and panel programming with a Windows-based computer and *modem (not sold by Silent Knight, see Table 1-1 for compatible modems). Enables remote viewing of detector status and event history.	
	5670 Silent Knight Software Suite (SKSS)	Facility management software. For remote viewing of detector status and event history. Requires a modem (not sold by Silent Knight).	
Misc.	7860 Telephone Cord	RJ31X cord for connecting phone line to the IFP-100.	
	RBB	Remote Battery Box for mounting backup batteries that are too large to fit into the main control panel cabinet. Dimensions: 16" W x 10" H x 6" D (40.64 cm W x 25.4 cm H x 15.24 cm D)	

Note: 5865-3, 5865-4, and 5880 can be used in any combination, up to a total of eight devices on one panel.

The following modems have been tested by Silent Knight for compatibility with the IFP-100 and the Silent Knight Software Suite software packages:

Table 1-1: Compatible Modems

Manufacturer	Model
US Robotics	28.8
Motorola	LifeStyle
	28.8, 3400 series
	Premier 33.6
MultiTech	MT19321ZDX

1.4 How to Contact Silent Knight

If you have a question or encounter a problem not covered in this manual, contact Silent Knight Technical Support at 800-328-0103 (or 763-493-6455). To order parts, contact Silent Knight Sales at 800-446-6444 (or 763-493-6435).

Limitations of Fire Alarm Systems

Manufacturer recommends that smoke and/or heat detectors be located throughout a protected premise following the recommendations of the current edition of the National Fire Protection Association Standard 72 (NFPA 72), manufacturer's recommendations, State and local codes, and the recommendations contained in Guide for the Proper Use of System Smoke Detectors, which is made available at no charge to all installing dealers. A study by the Federal Emergency Management Agency (an agency of the United States government) indicated that smoke detectors may not go off or give early warning in as many as 35% of all fires. While fire alarm systems are designed to provide warning against fire, they do not guarantee warning or protection against fire. A fire alarm system may not provide timely or adequate warning, or simply may not function, for a variety of reasons. For example:

- Particles of combustion or ?smoke from a developing fire may not reach the sensing chambers of smoke detectors because:

Barriers such as closed or partially closed doors, walls, or chimneys may inhibit particle or smoke flow.

Smoke particles may become cold, stratify, and not reach the ceiling or upper walls where detectors are located.

Smoke particles may be blown away from detectors by air outlets

Smoke particles may be drawn into air returns before reaching the detector.

In general, smoke detectors on one level of a structure cannot be expected to sense fires developing on another level.

- The amount of smoke present may be insufficient to alarm smoke detectors. Smoke detectors are designed to alarm at various levels of smoke density. If such density levels are not created by a developing fire at the location of detectors, the detectors will not go into alarm.
- Smoke detectors, even when working properly, have sensing limitations. Detectors that have photoelectronic sensing chambers tend to detect smoldering fires better than flaming fires, which have little visible smoke. Detectors that have ionizing-type sensing chambers tend to detect fast flaming fires better than smoldering fires. Because fires develop in different ways and are often unpredictable in their growth, neither type of detector is necessarily best and a given type of detector may not provide adequate warning of a fire.
- Smoke detectors are subject to false alarms and nuisance alarms and may have been disconnected by users. For example, a smoke detector located in or near a kitchen may go into nuisance alarm during normal operation of kitchen appliances. In addition, dusty or steamy environments may cause a smoke detector to falsely alarm. If the location of a smoke detector causes an abundance of false alarms or nuisance alarms, do not disconnect the smoke detector; call a professional to analyze the situation and recommend a solution.
- Smoke detectors cannot be expected to provide adequate warning of fires caused by arson, children playing with matches (especially within bedrooms), smoking in bed, violent explosions (caused by escaping gas, improper storage of flammable materials, etc.).
- Heat detectors do not sense particles of combustion and are designed to alarm only when heat on their sensors increases at a predetermined rate or reaches a predetermined level. Heat detectors are designed to protect property, not life.

- Warning devices (including horns, sirens, and bells) may not alert people or wake up sleepers who are located on the other side of closed or partially open doors. A warning device that activates on a different floor or level of a dwelling or structure is less likely to awaken or alert people. Even persons who are awake may not notice the warning if the alarm is muffled by noise from a stereo, radio, air conditioner or other appliance, or by passing traffic. Audible warning devices may not alert the hearing-impaired (strobes or other devices should be provided to warn these people). Any warning device may fail to alert people with a disability, deep sleepers, people who have recently used alcohol or drugs, or people on medication or sleeping pills.

Please note that:

- i) Strobes can, under certain circumstances, cause seizures in people with conditions such as epilepsy.
 - ii) Studies have shown that certain people, even when they hear a fire alarm signal, do not respond or comprehend the meaning of the signal. It is the property owner's responsibility to conduct fire drills and other training exercises to make people aware of fire alarm signals and instruct on the proper reaction to alarm signals.
 - iii) In rare instances, the sounding of a warning device can cause temporary or permanent hearing loss.
- Telephone lines needed to transmit alarm signals from a premises to a central station may be out of service or temporarily out of service. For added protection against telephone line failure, backup radio transmission systems are recommended.
 - System components, though designed to last many years, can fail at any time. As a precautionary measure, it is recommended that smoke detectors be checked, maintained, and replaced per manufacturer's recommendations.
 - System components will not work without electrical power. If system batteries are not serviced or replaced regularly, they may not provide battery backup when AC power fails.
 - Environments with high air velocity or that are dusty or dirty require more frequent maintenance.

In general, fire alarm systems and devices will not work without power and will not function properly unless they are maintained and tested regularly.

While installing a fire alarm system may make the owner eligible for a lower insurance rate, an alarm system is not a substitute for insurance. Property owners should continue to act prudently in protecting the premises and the people in their premises and should properly insure life and property and buy sufficient amounts of liability insurance to meet their needs.

Requirements and recommendations for proper use of fire alarm systems including smoke detectors and other fire alarm devices:

Early fire detection is best achieved by the installation and maintenance of fire detection equipment in all rooms and areas of the house or building in accordance with the requirements and recommendations of the current edition of the National Fire Protection Association Standard 72, *National Fire Alarm Code* (NFPA 72), the manufacturer's recommendations, State and local codes and the recommendations contained in Guide for the Proper Use of System Smoke Detectors, which is made available at no charge to all installing dealers. For specific requirements, check with the local Authority Having Jurisdiction (ex. Fire Chief) for fire protection systems.

Requirements and Recommendations include:

- Smoke Detectors shall be installed in sleeping rooms in new construction and it is recommended that they shall also be installed in sleeping rooms in existing construction.
- It is recommended that more than one smoke detector shall be installed in a hallway if it is more than 30 feet long.
- It is recommended that there shall never be less than two smoke detectors per apartment or residence.
- It is recommended that smoke detectors be located in any room where an alarm control is located, or in any room where alarm control connections to an AC source or phone lines are made. If detectors are not so located, a fire within the room could prevent the control from reporting a fire.
- All fire alarm systems require notification devices, including sirens, bells, horns, and/or strobes. In residential applications, each automatic alarm initiating device when activated shall cause the operation of an alarm notification device that shall be clearly audible in all bedrooms over ambient or background noise levels (at least 15dB above noise) with all intervening doors closed.
- It is recommended that a smoke detector with an integral sounder (smoke alarm) be located in every bedroom and an additional notification device be located on each level of a residence.
- To keep your fire alarm system in excellent working order, ongoing maintenance is required per the manufacturer's recommendations and UL and NFPA standards. At a minimum the requirements of Chapter 7 of NFPA 72 shall be followed. A maintenance agreement should be arranged through the local manufacturer's representative. Maintenance should be performed annually by authorized personnel only.
- The most common cause of an alarm system not functioning when a fire occurs is inadequate maintenance. As such, the alarm system should be tested weekly to make sure all sensors and transmitters are working properly.

Section 2

Agency Listings, Approvals, and Requirements

2.1 Federal Communications Commission (FCC)

The following information must be provided to the telephone company before the IFP-100 can be connected to the phone lines:

A	Manufacturer:	Silent Knight
B	Model Number:	IFP-100
C	FCC registration number:	AC6 USA-34758-AL-E
	Ringer equivalence:	0.8B
D	Type of jack:	RJ31X
E	Facility Interface Codes:	Loop Start: 02LS2 Ground Start: 02GS2
F	Service Order Code:	9.0F

This equipment complies with Part 68 of the FCC rules and the requirements adopted by ACTA. On the inside cover of this equipment is a label that contains, among other information, a product identifier. If requested, this information must be provided to the telephone company.

A plug and jack used to connect this equipment to the premises wiring and telephone network must comply with the applicable FCC Part 68 rules and requirements adopted by the ACTA. A compliant telephone cord (not provided) and modular jack must be utilized with this product. It is designed to be used with a modular jack that is also compliant.

The REN (ringer equivalence number) provided on this installation sheet is used to determine the number of devices that may be connected to the public switched telephone network. This number must not exceed 5.0. Since this product has an REN of 1.0, the number of devices is limited. The REN number is imbedded in the FCC registration number as 10B.

If the IFP-100 causes harm to the telephone network, the telephone company will notify you in advance that the temporarily discontinuance of service may be required. But if advance notice is not practical, the telephone company will notify the customer as soon as possible. Also, you will be advised of your right to file a complaint with the FCC if you believe it is necessary.

The telephone company may make changes in its facilities, equipment, operations or procedures that could affect the operation of the equipment. If this happens the telephone company will provide advance notice in order for you to make necessary modifications to maintain uninterrupted service.

If trouble is experienced with the IFP-100, for repair or warranty information, please contact Silent Knight at 1-800-328-0103 or www.silentknight.com. If the equipment is causing harm to the telephone network, the telephone company may request that you disconnect the IFP-100 until the problem has been resolved.

This product cannot be adjusted or repaired in the field. It must be returned to the factory for service.

This equipment is not designed for use with party line service. Connection to party line service is subject to state tariffs. You may contact the state public utility commission, public service commission or corporation commission for information.

Since the IFP-100 is a commercial fire alarm panel, it must be connected upstream of all other equipment utilizing the phone lines. If you have questions about the installation, contact your telephone company or a qualified installer.

Warning

This device has been verified to comply with FCC Rules Part 15. Operation is subject to the following conditions:
(1) This device may not cause radio interference, and (2) This device must accept any interference received, including interference that may cause undesired operation.

2.2 Underwriters Laboratories (UL)

2.2.1 Requirements for All Installations

General requirements are described in this section. When installing an individual device, refer to the specific section of the manual for additional requirements. The following subsections list specific requirements for each type of installation (for example, Central Station Fire Alarm systems, Local Protected Fire Alarm systems, and so on). See Section 8.6 for information on releasing operation.

1. All field wiring must be installed in accordance with NFPA 70 National Electric Code.
2. Use the addressable smoke detectors specified in Section 5 of this manual and or conventional detectors listed in the compatibility chart. (See Appendix A.)
3. Use UL listed notification appliances compatible with the IFP-100 from those specified in the Appendix A at the back of this manual.
4. A full system checkout must be performed any time the panel is programmed.

Restricted Options:

- The loss of AC signal is defaulted to 3 hours however the system allows settings from 0 - 3 hours. For UL certified installations this number must be set from 1 to 3 hours.
- The system allows the use of non-latching spot type smoke detectors. This feature may not be used in commercial applications whereby a general alarm is sounded. It is intended for elevator recall, door holding applications, and hotel/motel room applications.
- The system allows the Alarm Verification time to be set from 1 to 255 seconds. For UL certified installations the setting must be a minimum of 60 seconds.
- Call forwarding shall not be used.
- When two count is used detector spacing shall be cut in half, you shall not use the alarm verification feature, and no delay shall be used.
- P.A.S feature shall be used only with automatic detectors.

2.2.2 Requirements for Central Station Fire Alarm Systems

Minimum system requirements are one Silent Knight addressable initiating device.

1. Use both phone lines. Enable phone line monitors for both lines.
2. You must program a phone number and a test time so that the IFP-100 sends an automatic daily test to the central station.
3. Do not use the ground start option.

4. The AC Loss Hours option must be set from 1-3 hours.
5. The Attempts to Report option must be set for 5.

2.2.3 Requirements for Local Protected Fire Alarm Systems

At least one UL listed supervised notification appliance must be used. Minimum system requirements are one Silent Knight addressable initiating device.

2.2.4 Requirements for Remote Station Protected Fire Alarm Systems

Minimum system requirements are one Silent Knight addressable initiating device and either a 5220, Keltron 3158 or the built-in Digital Alarm Communicator Transmitter (DACT).

1. Do not exceed the current load restrictions shown in Section 3.6.1.3.
2. The AC Loss Hours option must be set from 1-3 hours.

2.2.5 Requirements for Auxiliary Protected Fire Alarm Systems for Fire Alarm Service

The Model 5220 Direct Connect module must be installed (see Section 4.15.3.1 for wiring).

Section 3

Before You Begin Installing

This section of the manual is intended to help you plan your tasks to facilitate a smooth installation. Please read this section thoroughly, especially if you are installing a IFP-100 panel for the first time.

3.1 What's in the Box?

The IFP-100 ships with the following hardware:

- A cabinet with all hardware assembled
- Two keys for the front door
- Ten 4.7K ohm end-of-line resistors
- A battery cable for batteries wired in series

3.2 Environmental Specifications

It is important to protect the IFP-100 control panel from water. To prevent water damage, the following conditions should be AVOIDED when installing the units:

- Mount indoors in dry locations only
- Do not mount directly on exterior walls, especially masonry walls (condensation)
- Do not mount directly on exterior walls below grade (condensation)
- Protect from plumbing leaks
- Protect from splash caused by sprinkler system inspection ports
- Do not mount in areas with humidity-generating equipment (such as dryers, production machinery)

When selecting a location to mount the IFP-100 control panel, the unit should be mounted where it will NOT be exposed to temperatures outside the range of 0°C-49°C (32°F-120°F) or humidity not exceeding 93% noncondensing.

3.3 Electrical Specifications

Table 3-1 list the terminal block on the IFP-100 as well as a description of the each individual terminal and their respective electrical rating. For location of the terminals refer to Table 3-1.

Table 3-1: Terminal Descriptions and Electrical Specifications

Terminal No.	Label		Description	Rating	
	Group	Individual		Voltage	Current
Terminal Block 1	AC INPUT	B	AC input (hot)	120 VAC, 60 Hz	3.6 A
		Earth	Earth Ground	N/A	N/A
		W	AC input (neutral)	120 VAC, 60 Hz	3.6 A
Terminal Block 2	SLC IN	-	Used for Class A installations	32 VDC	150 mA
		+			
	SLC OUT	-	SLC terminals	32 VDC	150 mA
		+			
	SLC PROG	-	Used for programming SLC Detectors	32 VDC	150 mA
		+			
Terminal Block 3	TELCO 1	RING	Phone Line 1 Telco Ring		
		TIP	Phone Line 1 Telco Tip		
	PHONE 1	RING	Phone Line 1 Phone Ring		
		TIP	Phone Line 1 Phone Tip		
	TELCO 2	RING	Phone Line 2 Telco Ring		
		TIP	Phone Line 2 Telco Tip		
Terminal Block 4	TROUBLE	NC	Normally closed relay contact	24 VDC	2.5 A, resistive
		COM	Common terminal		
		NO	Normally open relay contact		
	RELAY 1	NC	Normally closed relay contact	24 VDC	2.5 A, resistive
		COM	Common terminal		
		NO	Normally open relay contact		
RELAY 2	NC	Normally closed relay contact	24 VDC	2.5 A, resistive	
	COM	Common terminal			
	NO	Normally open relay contact			
Terminal Block 5	NAC1*	-	Notification Appliance Circuit/Auxiliary power	24 VDC	3.0 Amp NAC or Aux power
		+			
	NAC2*	-	Notification Appliance Circuit/Auxiliary power	24 VDC	3.0 Amp NAC or Aux power
		+			
NAC3*	-	Notification Appliance Circuit/Auxiliary power	24 VDC	3.0 Amp NAC or Aux power	
	+				
NAC4*	-	Notification Appliance Circuit/Auxiliary power	24 VDC	3.0 Amp NAC or Aux power	
	+				
Terminal Block 5	SBUS	B	SBUS Communication	5 VDC	100 mA
		A			
		+	SBUS Power	24 VDC	1.0 A
	-				
	BATTERY	+	To Positive battery terminal	24 VDC	Up to 35 Ah (see Section 4.3 for details)
		-	To Negative battery terminal		

* Regulated/special application when used for releasing.

3.4 Wiring Specifications

Induced noise (transfer of electrical energy from one wire to another) can interfere with telephone communication or cause false alarms. To avoid induced noise, follow these guidelines:

- Isolate input wiring from high current output and power wiring. Do not pull one multi-conductor cable for the entire panel. Instead, separate the wiring as follows:

High voltage	AC power Terminals
SLC loops	
Audio input/output	Phone line circuits
Notification circuits	NAC1 through NAC4
SBUS	
Relay circuits	

- Do not pull wires from different groups through the same conduit. If you must run them together, do so for as short a distance as possible or use shielded cable. Connect the shield to earth ground at the panel. You must route high and low voltages separately.
- Route the wiring around the inside perimeter of the cabinet. It should not cross the circuit board where it could induce noise into the sensitive microelectronics or pick up unwanted RF noise from the high speed circuits. See Figure 3-1 for an example.
- High frequency noise, such as that produced by the inductive reactance of a speaker or bell, can also be reduced by running the wire through ferrite shield beads or by wrapping it around a ferrite toroid.

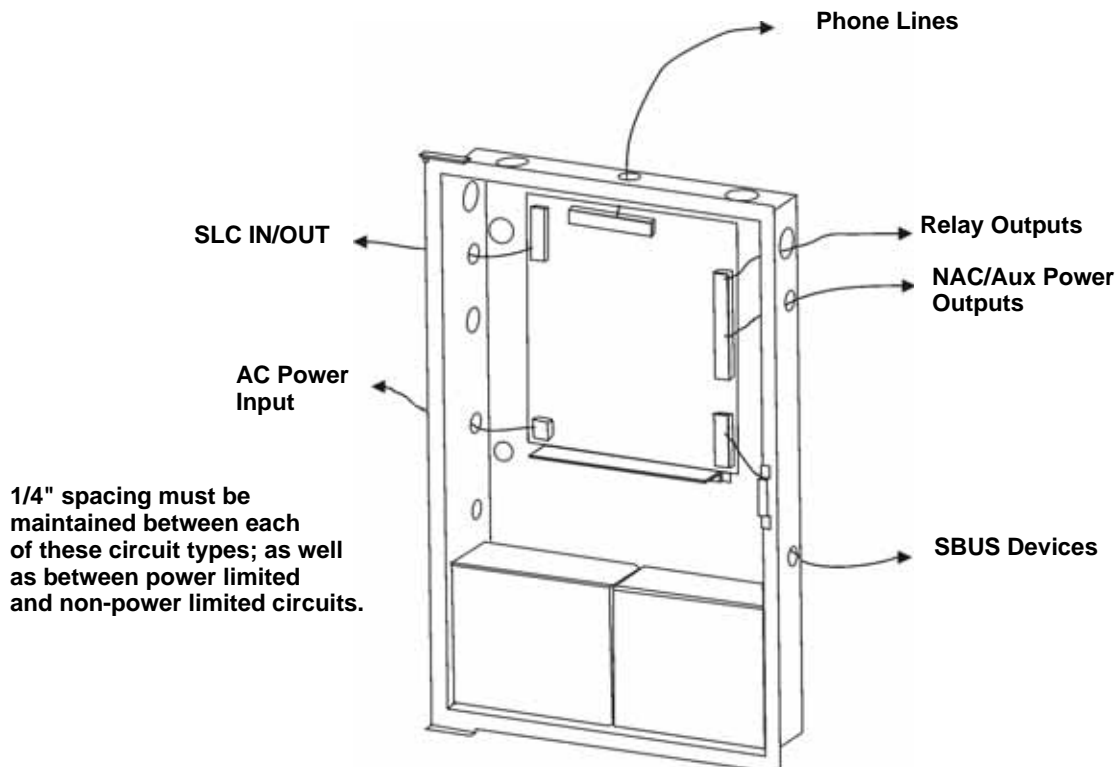

Figure 3-1 Wire Routing Example

3.5 Board Assembly Diagram

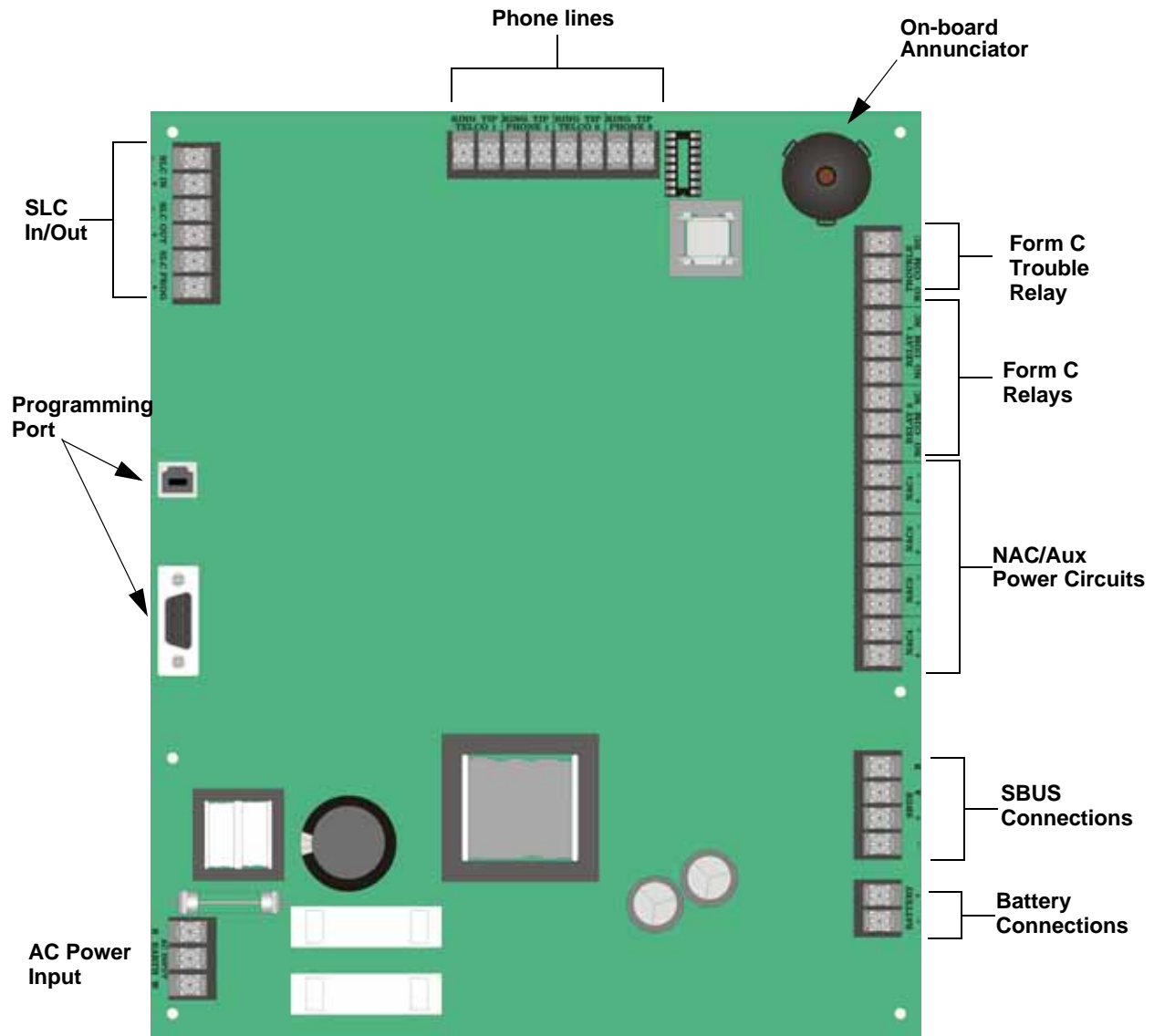

Figure 3-2 Model IFP-100 Assembly

Figure 3-2 shows the circuit boards and annunciator that attach the IFP-100 assembly to the cabinet. If you should need to remove the board assembly for repair, remove the nine mounting screws (six on the main circuit board and 3 on the heat-sink) which hold the assembly in the cabinet. Then lift the entire assembly out of the cabinet.

3.6 Calculating Current Draw and Standby Battery

This section is for helping you determine the current draw and standby battery needs if you are using IDP addressable devices (Table 3-2) or Hochiki addressable devices (Table 3-3).

3.6.1 Current Draw Worksheet Requirements

The following steps must be taken when determining IFP-100 current draw and standby battery requirements.

1. Use the Current Draw Worksheet to determine current draw and standby battery requirements. Use Table 3-2 if installing IDP SLC Devices and Table 3-3 if installing Hochiki SLC Devices to determine current draw. For the IFP-100, the worst case current draw is listed for the panel, addressable devices, and all SBUS expanders. Fill in the number of addressable devices that will be used in the system and compute the current draw requirements for alarm and standby. Record this information in the Current Draw Worksheet on Line A.
2. Add up the current draw for all auxiliary devices and record in the table at Line B.
3. Add up all notification appliance loads and record in the table at Line C.
4. For notification appliance circuits and auxiliary devices not mentioned in the manual, refer to the device manual for the current ratings.
5. Make sure that the total alarm current you calculated, including current for the panel itself, does not exceed 6.0 A. This is the maximum alarm current for the IFP-100 control panel.

If the current is above 6.0 A you will need to use a notification power expander(s) such as the Silent Knight 5496 intelligent power module, to distribute the power loads so that the IFP-100 or the power expanders do not exceed their power rating. Refer to the current draw worksheets provided with the 5496 manual so you do not exceed their power requirements.

6. Complete the remaining instructions in the Current Draw Worksheet for determining battery size requirements.

3.6.1.1 Current Draw Worksheet for IDP SLC Devices

Use Table 3-2 to determine current requirements during alarm/battery standby operation when IDP SLC devices are installed. You can install up to 99 IDP detectors *and* 99 IDP modules. (Copy the page if additional space is required.)

Table 3-2: Current Draw Worksheet for IDP Devices

Device	# of Devices	Current per Device		Standby Current	Alarm Current	
For each device use this formula: This column X This column = Current per number of devices.						
Fire Panel (Current draw from battery)	1	Standby:	170 mA	170 mA		
		Alarm:	325 mA		325 mA	
Addressable SLC Detectors						
IDP-Photo	(99 max.) ¹	Standby/Alarm: 0.27 mA		mA	mA	
IDP-Photo-T				mA	mA	
IDP-Ion				mA	mA	
IDP-Heat				mA	mA	
IDP-Heat-HT				mA	mA	
IDP-Beam (without integral test)		SLC	Standby/Alarm:	2 mA		
		Aux. Pwr	Standby:	2 mA	mA	
IDP-Beam-T (with integral test)		Aux. Pwr	Alarm:	8.5 mA		mA
		SLC	Standby/Alarm:	2 mA		
IDP-Beam-T (with integral test)		Aux. Pwr	Standby:	2 mA	mA	
		Aux. Pwr	Alarm:	8.5 mA		mA
IDP-Pduct (non-relay)		SLC	Standby/Alarm:	0.27 mA	mA	mA
IDP-Pduct-R (with relay)		Aux. Pwr	Standby:	26 mA ²	mA	
		Aux. Pwr	Alarm:	87 mA ²		mA
	SLC	Standby/Alarm:	0.27 mA	mA	mA	
IDP-Acclimate	Standby/Alarm:		0.3 mA	mA	mA	
IDP-Heat-ROR				mA	mA	
Addressable SLC Modules						
IDP-Monitor	(99 max.) ¹	Standby/Alarm: 0.3 mA		mA	mA	
IDP-Control				mA	mA	
IDP-Minimon				mA	mA	
IDP-Pull-SA/IDP-Pull-DA				mA	mA	
IDP-Monitor-2		Standby/Alarm:	0.75 mA	mA	mA	
IDP-Monitor-10		Standby/Alarm:	3.5 mA	mA	mA	
IDP-Relay-6		Standby/Alarm:	1.45 mA	mA	mA	
IDP-Control-6		Standby/Alarm:	2.25 mA	mA	mA	
IDP-Relay					mA	mA
IDP-Zone		Standby/Alarm:		0.2 mA	mA	mA
IDP-Zone-6					mA	mA

Table 3-2: Current Draw Worksheet for IDP Devices

Device	# of Devices	Current per Device		Standby Current	Alarm Current
SLC Accessories					
SSB501BHT Sounder Base	(99 max.)	Aux Pwr	Standby: 1 mA	mA	
			Alarm: 15 mA		mA
		SLC	Alarm: 0.7 mA		mA
SSB224RB Relay Base		Standby/Alarm: 0.5 mA		mA	mA
RTS451/451 KEY		Alarm: 7.5 mA			mA
RA400Z		Alarm: 10 mA			mA
SLC Isolator Devices					
IDP-Iso (Isolator Module)	(100 max.)	Standby/Alarm: 0.45 mA		mA	mA
SSB224BI Isolator Base		Standby/Alarm: 0.5 mA			
Accessories Modules					
RA-100 Remote Fire Alarm Annunciator	(8 max.)	Standby: 20 mA		mA	
		Alarm: 25 mA			mA
RA-1000 Remote Fire Alarm Annunciator	(8 max.)	Standby: 20 mA		mA	
		Alarm: 25 mA			mA
5824 Serial / Parallel Module	(2 max.)	Standby/Alarm: 45 mA		mA	mA
5496 Notification Power Expander	(8 max.)	Standby/Alarm: 10 mA		mA	mA
5865-4 LED Annunciator (with reset and silence switches)	(8 max.)	Standby: 35 mA		mA	
		Alarm: 145 mA			mA
5865-3 LED Annunciator	(8 max.)	Standby: 35 mA		mA	
		Alarm: 145 mA			mA
5880 LED I/O Module	(8 max.)	Standby: 35 mA		mA	
		Alarm: 200 mA			mA
5883 Relay Interface	(32 max.)	Standby: 0 mA		mA	
		Alarm: 220mA (22 mA per relay)			mA
Total System Current					
Auxiliary Devices ³		Refer to devices manual for current rating.			
		Alarm/Standby: mA		mA	mA
		Alarm/Standby: mA		mA	mA
		Alarm/Standby: mA		mA	mA
		Alarm/Standby: mA		mA	mA
Auxiliary Devices Current					
Notification Appliance Circuits		Refer to devices manual for current rating.			
		Alarm: mA			mA
		Alarm: mA			mA
		Alarm: mA			mA
		Alarm: mA			mA
Notification Appliances Current					mA
Total current ratings of all devices in system (line A + line B + C)				mA	mA
Total current ratings converted to amperes (line D x .001):				A	A
Number of standby hours (24 or 60 for NFPA 72, chapter 1, 1-5.2.5):				H	
Multiply lines E and F.				Total standby AH	AH

Table 3-2: Current Draw Worksheet for IDP Devices

	Device	# of Devices	Current per Device	Standby Current	Alarm Current
H	Alarm sounding period in hours. (For example, 5 minutes = .0833 hours)				H
I	Multiply lines E and H.			Total alarm AH	AH
J	Add lines G and I. ⁴			AH	Total ampere hours required

1. Total does not include isolator devices or accessory bases.
2. If using 24 VDC aux power only. No standby or alarm current for battery calculation if using 24 VAC, 120 VAC or 240 VAC.
3. If using door holders, you do not need to consider door holder current for alarm/battery standby, because power is removed during that time. However, during normal operation, door holders draw current and must be included in the 6.0A total current that can be drawn from the panel.
4. Use next size battery with capacity greater than required.

3.6.1.2 Current Draw Worksheet Hochiki for SLC Devices

Use Table 3-3 to determine current requirements during alarm/battery standby operation when Hochiki SLC devices are installed. (Copy the page if additional space is required.)

Table 3-3: Current Draw Worksheet for Hochiki Devices

Device	# of Devices	Current per Device		Standby Current	Alarm Current
For each device use this formula: This column X This column = Current per number of devices.					
IFP-100 Fire Panel (Current draw from battery)	1	Standby:	170 mA	170 mA	
		Alarm:	325 mA		325 mA
Addressable SLC Devices					
SD500-AIM	(127 max.) ¹	Standby/Alarm: 0.55 mA		mA	mA
SD500-MIM				mA	mA
SD500-ARM				mA	mA
SD500-PS					
SD505-AHS				mA	mA
SD505-AIS				mA	mA
SD505-APS				mA	mA
SD500-ANM	(127 max.) ¹	Aux. Pwr	Standby: 8 mA	mA	
			Alarm: 60 mA		mA
		SLC	Standby/Alarm: 55 mA	mA	mA
SD500-LED	(40 max.) ¹	Aux. Pwr	Standby: 10 mA	mA	
			Alarm: 220 mA		mA
			LED: 10 mA	mA	mA
		SLC	Standby/Alarm: 0.55 mA	mA	mA
SD500-SDM	(127 max.) ¹	SLC	Standby/Alarm: 0.55 mA	mA	mA
		Aux. Pwr	Standby: 20 mA	mA	
			Alarm: 106 mA		mA
SLC Accessory Bases					
SD505-6RB	(127 max.)	Standby/Alarm: 0.082 mA		mA	mA
SD505-6SB	(127 max.)	Aux. Pwr	Standby: 1 mA	mA	
			Alarm: 32 mA		mA
		SLC	Standby/Alarm: 0.082 mA	mA	mA
SD505-ADHR	(127 max.)	Aux. Pwr	Standby: 35 mA ²	mA	
			Alarm: 75 mA ²		mA
		SLC	Standby/Alarm: 0.082 mA	mA	mA
SD505-DTS	(127 max.)	None, included with SD505-ADHR worst case.			
SD505-ADH	(127 max.)	None, included with detector current.			
SLC Isolator Devices					
SD505-LIM	(254 max.)	Standby/Alarm: 0.092 mA		mA	mA
SD505-6IB	(127 max.)				
Accessories Modules					

Table 3-3: Current Draw Worksheet for Hochiki Devices

Device	# of Devices	Current per Device	Standby Current	Alarm Current
RA-100 Remote Fire Alarm Annunciator	(8 max.)	Standby:	20 mA	mA
		Alarm:	25 mA	mA
RA-1000 Remote Fire Alarm Annunciator		Standby:	20 mA	mA
		Alarm:	25 mA	mA
5824 Serial/Parallel Printer Interface Module	(2 max.)	Standby/Alarm:	45 mA	mA
5496 Notification Power Expander	(8 max.)	Standby/Alarm:	10 mA	mA
RPS-1000 IntelliKnight Power Expander		Standby/Alarm:	10 mA	mA
5865-4 LED Annunciator (with reset and silence switches)	(8 max.)	Standby:	35 mA	mA
		Alarm:	145 mA	mA
5865-3 LED Annunciator		Standby:	35 mA	mA
		Alarm:	145 mA	mA
5880 LED I/O Module		Standby:	35 mA	mA
		Alarm:	200 mA	mA
5883 Relay Interface	(32 max.)	Standby:	0 mA	mA
		Alarm:	220 mA (22 mA per relay)	mA
VIP-VCM Voice Control Module	(1 max.)	Standby:	50 mA	mA
		Alarm:	125 mA	mA
VIP-SW16 Switch Expander	(3 max.)	Standby:	10 mA	mA
		Alarm:	75 mA	mA
VIP-50 Audio Amplifier 50 Watt with/without VIP-CE4	(8 max.)	Standby:	10 mA	mA
		Alarm:	10 mA	mA
VIP-RM Remote Microphone	(2 max.)	Standby:	50 mA	mA
		Alarm:	125 mA	mA
Total System Current				
Auxiliary Devices ³	Refer to devices manual for current rating.			
		Alarm/Standby:	mA	mA
		Alarm/Standby:	mA	mA
		Alarm/Standby:	mA	mA
		Alarm/Standby:	mA	mA
Auxiliary Devices Current				
Notification Appliance Circuits	Refer to devices manual for current rating.			
		Alarm:	mA	mA
		Alarm:	mA	mA
		Alarm:	mA	mA
		Alarm:	mA	mA
Notification Appliances Current				mA
D	Total current ratings of all devices in system (line A + line B + C)			mA
E	Total current ratings converted to amperes (line D x .001):			A
F	Number of standby hours (24 or 60 for NFPA 72, chapter 1, 1-5.2.5):			H
G	Multiply lines E and F.		Total standby AH	AH

Table 3-3: Current Draw Worksheet for Hochiki Devices

	Device	# of Devices	Current per Device	Standby Current	Alarm Current
H	Alarm sounding period in hours. (For example, 5 minutes = .0833 hours)				H
I	Multiply lines E and H.			Total alarm AH	AH
J	Add lines G and I. ⁴			Total ampere hours required	AH

1. Total does not include isolator devices or accessory bases.
2. If using 24 VDC aux power only. No standby or alarm current for battery calculation if using 24 VAC, 120 VAC or 240 VAC.
3. If using door holders, you do not need to consider door holder current for alarm/battery standby, because power is removed during that time. However, during normal operation, door holders draw current and must be included in the 6.0A total current that can be drawn from the panel.
4. Use next size battery with capacity greater than required.

3.6.1.3 Maximum Battery Standby Load

The table below shows the maximum battery standby load for the IFP-100 based on 24 and 60 hours of standby. The standby load calculations of line D in the Current Draw Calculation Worksheet (Table 3-2 for IDP devices and Table 3-3 for Hochiki devices) must be less than the number shown in the table below for the battery size used and standby hours required.

Table 3-4: Maximum Battery Standby Load

Rechargeable Battery Size	Max. Load for 24 hrs. Standby, 5 mins. Alarm	*Max. Load for 60 hrs. Standby, 5 mins. Alarm
7 AH	221 mA	85 mA
12 AH	475 mA	190 mA
18 AH	685 mA	270 mA
35 AH	1.1 A	450 mA

* Required for NFPA 72 Auxiliary Protected Fire Alarm systems for Fire Alarm Service (City Box) and Remote Station Protected Fire Alarm systems (Polarity Reversal) and Digital Alarm Communicator/Transmitter (DACT).

Warning!

Silent Knight does not support the use of batteries smaller than those listed in table above. If you use a battery too small for the installation, the system could overload the battery resulting in the installation having less than the required 24 hours standby power. Use Table 3-4 to calculate the correct battery amperes/hour rating needed for your installation.

Section 4

Control Panel Installation

Caution!

To avoid the risk of electrical shock and damage to the unit, power should be OFF at the control panel while installing or servicing.

4.1 Mounting the Control Panel Cabinet

Read the environmental specifications in Section 3.2 before mounting the IFP-100 panel.

The IFP-100 cabinet dimensions are:

16" W x 26.4" H x 3.5" D (40.64 cm W x 67.06 cm H x 8.89 cm D).

The IFP-100 panel should be located within a secured area, where it is accessible to main drop wiring runs and where it can be easily tested and serviced. End-users responsible for maintaining the panel should be able to hear alarms and troubles. When selecting a location, keep in mind that the panel itself is the main source of alarm and trouble annunciation.

When mounting on interior walls, use appropriate screw anchors in plaster. When mounting on concrete, especially when moisture is expected, attach a piece of 3/4 inch plywood to the concrete surface and then attach the IFP-100 to the plywood. Also mount any other desired components to the plywood.

DO NOT flush-mount the IFP-100 cabinet in a wall designated as a fire break.

4.1.1 Preventing Water Damage

Water damage to the fire system can be caused by moisture entering the cabinet through the conduits. Conduits that are installed to enter the top of the cabinet are most likely to cause water problems. Installers should take reasonable precautions to prevent water from entering the cabinet. Water damage is not covered under warranty.

4.1.2 Removing the IFP-100 Assembly from the Housing

If it should ever be necessary to remove the control panel assembly from the cabinet for repair, do so by removing the screws that hold the control panel in to the cabinet. Do not attempt to disassemble the circuit boards.

4.2 AC Connection

At installation, connect the AC terminals to the power source as shown in Figure 4-1. It may be necessary for a professional electrician to make this connection.

The AC terminals are rated at 120 VAC, 60 Hz, 3.6A.

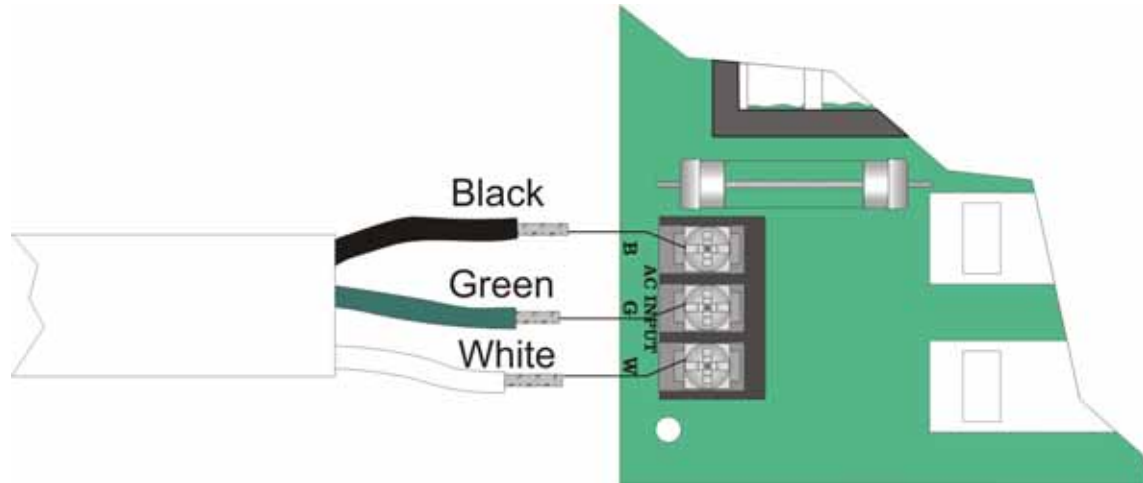

Figure 4-1 120VAC Power Connection

4.3 Battery Connection

The control panel battery charge capacity is 7.0 to 35 AH. The main control cabinet can house batteries up to 18 AH, larger capacity batteries can be housed in a RBB (see Section 4.3.1 for details). Use 12V batteries of the same AH rating. Determine the correct AH rating as per your current load calculation (see Section 3.6).

Wire batteries in series to produce a 24-volt equivalent. Do not parallel batteries to increase the AH rating.

The following steps and diagram explain how to connect the batteries.

1. Connect the black wire from the control panel negative (–) battery terminal to the negative (–) side of Battery #2.
2. Connect the jumper wire provided (P/N 140694) from the positive (+) side of Battery #2 to the (–) negative side of Battery #1.
3. Connect the red wire from the control panel positive (+) terminal to the positive (+) side of Battery #1.

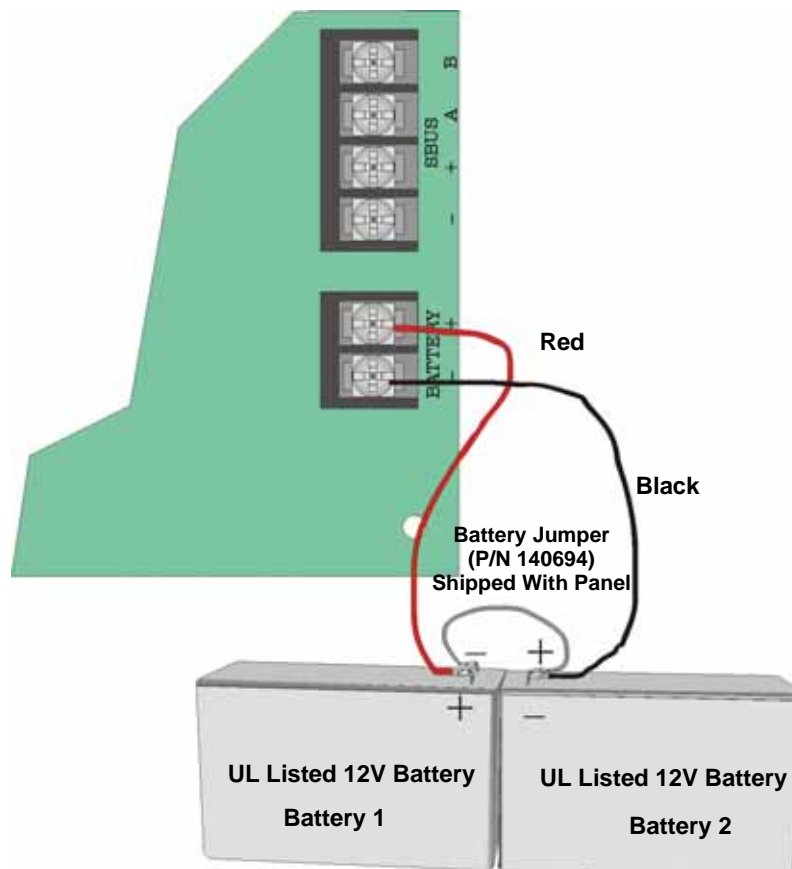

Figure 4-2 Battery Connection

4.3.1 RBB Accessory Cabinet

The Model RBB Accessory cabinet can be used when your backup batteries requirements use backup batteries that are too large to fit into the main control panel cabinet. The RBB cabinet holds batteries up to the 35 AH size. The RBB dimensions are 16" W x 10" H x 6" D (40.64 cm W x 25.4 cm H x 15.24 cm D).

4.3.1.1 Installing the RBB Accessory Cabinet and Batteries

To properly install the accessory cabinet and backup batteries, follow these steps:

1. Mount the accessory cabinet. See figure Figure 4-3 for the four cabinet mounting holes.
 - If mounting onto drywall the accessory cabinet must be mounted onto 3/4-inch plywood. This is necessary because the weight of the batteries inside the accessory cabinet could cause the cabinet to pull away from the drywall.
 - When mounting on concrete, especially when moisture is expected, attach a piece of 3/4-inch plywood to the concrete surface and then attach the RBB cabinet to the plywood.
 - If using the battery cable extenders provided (P/N 140643), mount the RBB cabinet no more than 18" away from the main control panel cabinet. This will ensure that the battery cables reach the battery terminals.

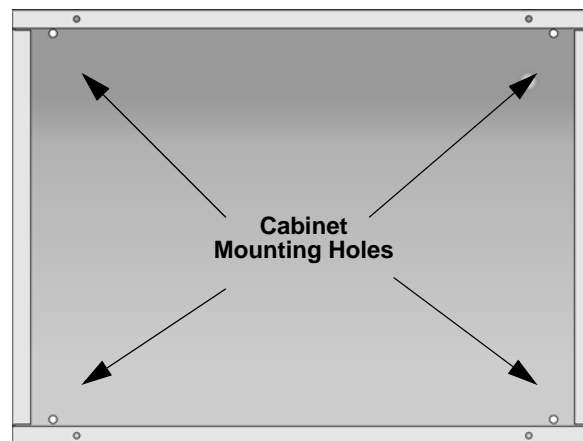

Figure 4-3 RBB Cabinet Mounting Holes

2. Connect the main control panel battery cables to the battery cable extenders as shown in Figure 4-4.

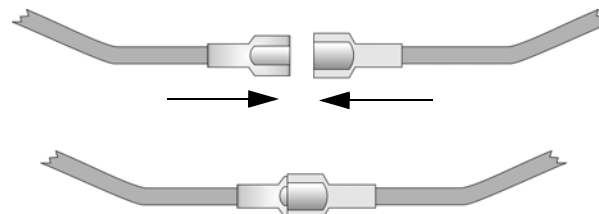

Figure 4-4 Splicing Control Panel Battery Cable to RBB Battery Cable Extenders

- Run extended battery cable from control panel cabinet through conduit to RBB cabinet. See Figure 4-5.

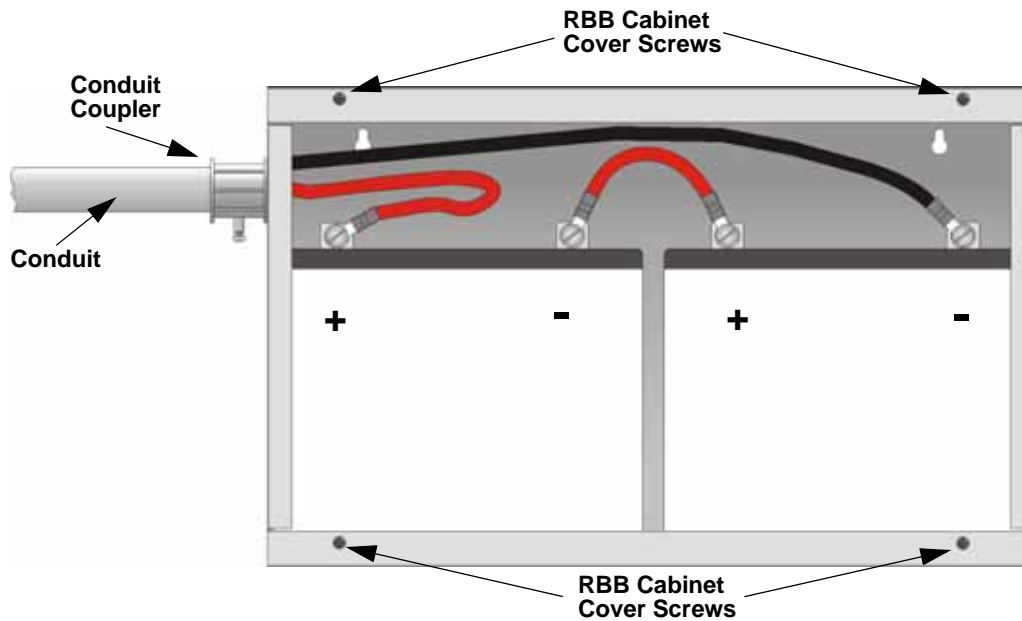

Figure 4-5 Battery Connections in the RBB Cabinet

Note: Figure 4-5 is an example of how the wire connections can be routed. However, any other cabinet knock-outs (on either the main control panel or the RBB cabinet), that are not previously being used may be utilized to connect conduit between the two cabinets.

- Connect battery leads to the backup battery terminals. See Figure 4-5.
Observe the proper polarity to prevent damage to the batteries or the control panel.
- Insert the RBB cover screws into the cover mounting holes (see Figure 4-5).
Screw the cover screw 3/4 of the way into the cover mounting hole.
- Align the cover plate mounting keyhole over the cover mounting screws. See Figure 4-6.

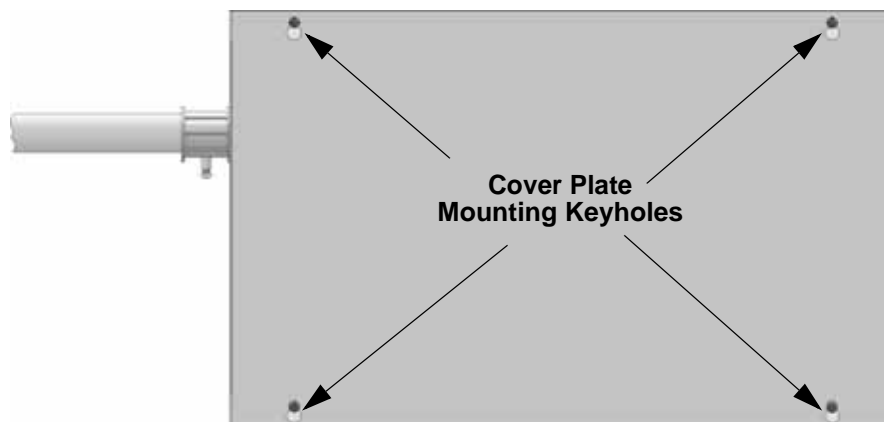

Figure 4-6 Cover Plate Mounting Keyholes and Cover Mounting Screws Alignment

- Slide the cover into place and tighten the cover mounting screws. See Figure 4-6.

4.4 SBUS Wiring

This section contains information on calculating SBUS wire distances and the types of wiring configurations (Class B).

4.4.1 Calculating Wiring distance for SBUS modules

The following instructions will guide you in determining the type of wire and the maximum wiring distance that can be used with control panel SBUS accessory modules.

To calculate the wire gauge that must be used to connect SBUS modules to the control panel, it is necessary to calculate the total worst case current draw for all modules on a single 4-conductor bus. The total worst case current draw is calculated by adding the individual worst case currents for each module. The individual worst case values are shown in the table below.

Note: Total worst case current draw on a single SBUS cannot exceed 1 amp.

Table 4-1

Model Number	Worst Case Current Draw
RA-100 or RA-1000 Fire Annunciator	.100 amps
5824 Serial/Parallel Printer Interface Module	.040 amps
5880 LED I/O Module	.250 amps
5865 LED Fire Annunciator	.200 amps
5496 Intelligent Power Supply	.010 amps
RPS-1000 Intelligent Power Supply	.010 amps
VIP-50	.010 amps
VIP-VCM/VIP-VCM with VIP-SW16	.125 amps/.200 amps
VIP-RM/VIP-RM with VIP-SW16	.125 amps/.200 amps

After calculating the total worst case current draw, Table 4-2 specifies the maximum distance the modules can be located from the panel on a single wire run. The table insures 6.0 volts of line drop maximum. In general, the wire length is limited by resistance, but for heavier wire gauges, capacitance is the limiting factor.

These cases are marked in the chart with an asterisk (*). Maximum length can never be more than 6,000 feet, regardless of gauge used. (The formula used to generate this chart is shown in the note below).

Table 4-2: Wiring Distances Per Wire Gauge Using Copper Wire

Wiring Distance: SBUS Modules to Panel				
Total Worst Case Current Draw (amps)	22 Gauge	18 Gauge	16 Gauge	14 Gauge
0.100	1852 ft.	4688 ft.	* 6000 ft.	* 6000 ft.
0.200	926 ft.	2344 ft.	3731 ft.	5906 ft.
0.300	617 ft.	1563 ft.	2488 ft.	3937 ft.
0.400	463 ft.	1172 ft.	1866 ft.	2953 ft.
0.500	370 ft.	938 ft.	1493 ft.	2362 ft.
0.600	309 ft.	781 ft.	1244 ft.	1969 ft.
0.700	265 ft.	670 ft.	1066 ft.	1687 ft.
0.800	231 ft.	586 ft.	933 ft.	1476 ft.
0.900	206 ft.	521 ft.	829 ft.	1312 ft.
1.000 (Max)	185 ft.	469 ft.	746 ft.	1181 ft.

Note: The following formulas were used to generate the wire distance chart:

$$\text{Maximum Resistance (Ohms)} = \frac{6.0 \text{ Volts}}{\text{Total Worst Case Current Draw (amps)}}$$

$$\text{Maximum Wire Length (Feet)} = \frac{\text{Maximum Resistance (Ohms)}}{\text{Rpu}} \quad * 500$$

(6000 feet maximum)

where: Rpu = Ohms per 1000 feet for various Wire Gauges (see table below)

Table 4-3: Typical Wire Resistance Per 1000 ft. Using Copper Wire

Wire Gauge	Ohms per 1000 feet (Rpu)
22	16.2
18	6.4
16	4.02
14	2.54

Wiring Distance calculation example:

Suppose a system is configured with the following SBUS modules:

- 2 - Module RA-1000 Fire Annunciator
- 1 - 5496 Notification Power Expander
- 1 - 5865 LED Fire Annunciator
- 1 - 5824 Serial/Parallel Printer Interface Module

The total worst case current is calculated as follows:

RA-1000 Current Draw	= 2 x .100 amps	= .200 amps
5496 Current Draw	= 1 x .010 amps	= .010 amps
5865 Current Draw	= 1 x .200 amps	= .200 amps
5824 Current Draw	= 1 x .040 amps	= .040 amps
Total Worst Case Current Draw		= .450 amps

Using this value, and referring to the Wiring Distance table, it can be found that the available options are:

- 370 feet maximum using 22 Gauge wire
- 938 feet maximum using 18 Gauge wire
- 1493 feet maximum using 16 Gauge wire
- 2362 feet maximum using 14 Gauge wire

4.4.2 Wiring Configurations

Figure 4-7 illustrates Class B configuration.

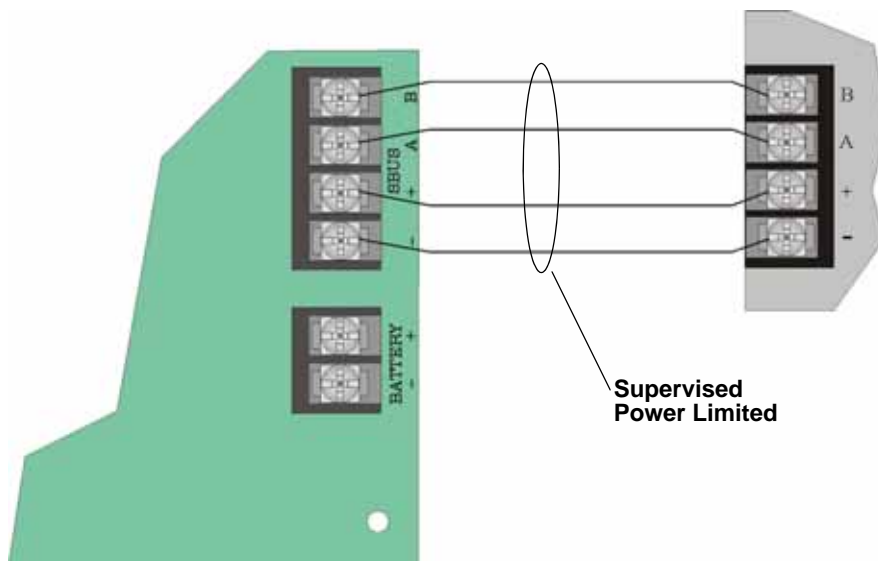

Figure 4-7 SBUS Class B Wiring

4.5 RA-100 Remote Annunciator Installation

The optional Model RA-100 Remote Annunciator, shown in Figure 4-14, performs the same functions as the on-board annunciator. Operation is identical. The RA-100 can be surface or flush mounted.

Up to 8 RA-100s can be added to the IFP-100 system.

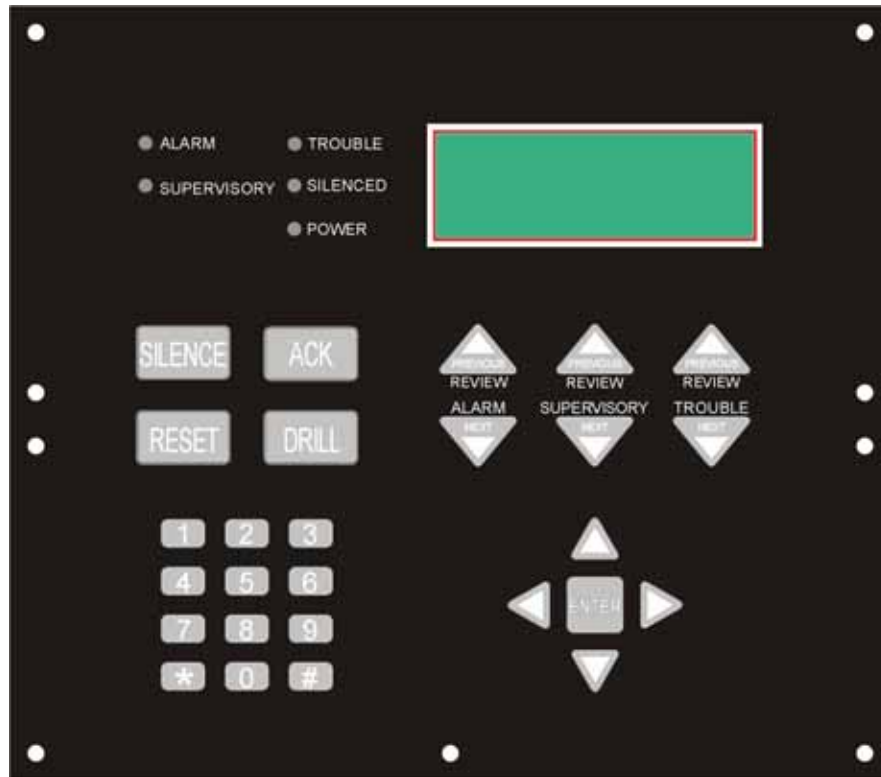

Figure 4-8 Model RA-100 Remote Annunciator, Front View

RA-100 installation involves the following steps:

1. Make sure power is off at the panel.
2. Mount the RA-100 in the desired location (see Section 4.5.1).
3. Connect the RA-100 to the panel (see Section 4.4.2).
4. Use the dipswitches on the back of the RA-100 to assign an ID# to the RA-100 (see Section 4.10.1).
5. The new RA-100 module must be added to the system through programming. JumpStart will add the module automatically (see Section 6.1). You can also add it manually (see Section 7.3.2). Select a name, if desired (see Section 7.3.1.1).

4.5.1 Mounting the RA-100

This section of the manual describes mounting the remote annunciator. The annunciator can be flush- or surface-mounted.

4.5.1.1 Flush Mounting

This section of the manual describes flush mounting.

Follow these steps to flush mount the RA-100

1. The back box dimensions are 9-9/32" w x 8-3/8" h. The minimum depth 2". The back box can be mounted prior to the complete installation of the RA-100 using any of the mounting holes shown in Figure 4-9.

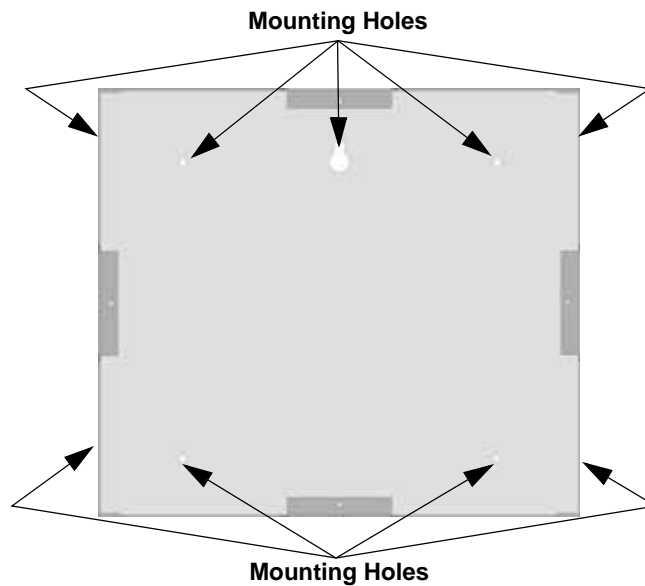

Figure 4-9 Back Box Mounting Holes

2. Remove knockout holes as needed for wires. See Figure 4-10 for backbox knockout locations

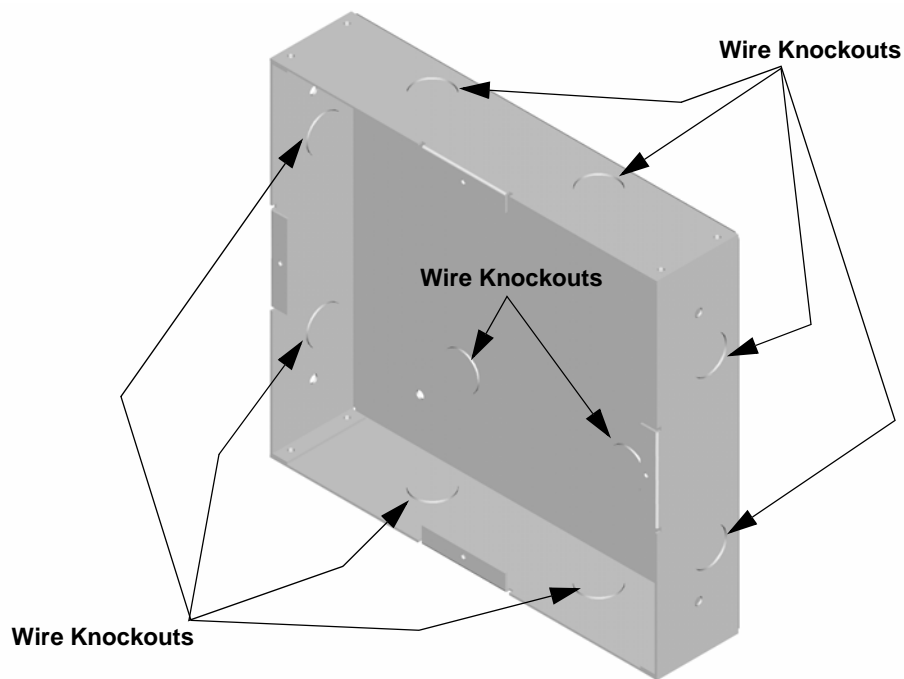

Figure 4-10 Back Box Knockout Locations

3. Wire the Annunciator board to the main control panel. See Figure 4-7.
4. Attach the annunciator and door assembly to back box as shown in Figure 4-11 using the supplied screws.

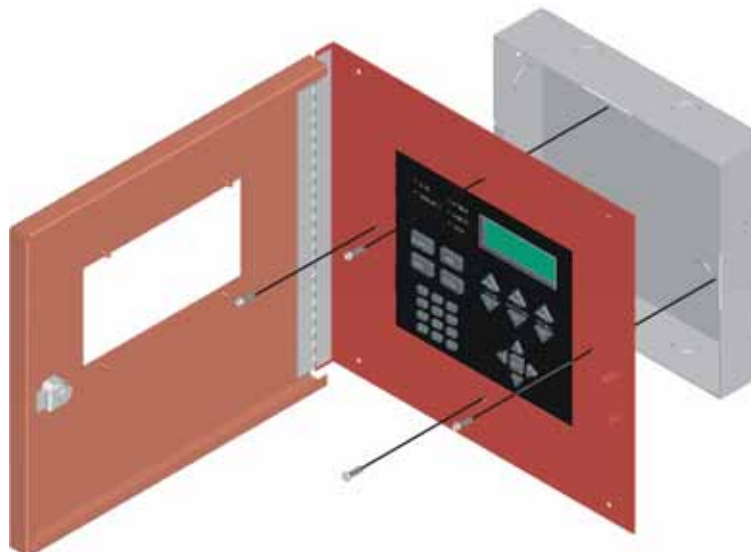

Figure 4-11 Attaching Annunciator/Door Assembly to Backbox

4.5.1.2 Surface Mounting

The optional Model RA-100TG/TR trim ring kit is available for use when surface mounting.

1. Remove the desired knock out. See Figure 4-10.
2. To properly mount the back box, insert a single screw into the key shaped mounting hole. Do not tighten all the way. See Figure 4-12. Place a level on top of the back box, with the back box level insert the rest of the mounting screws.

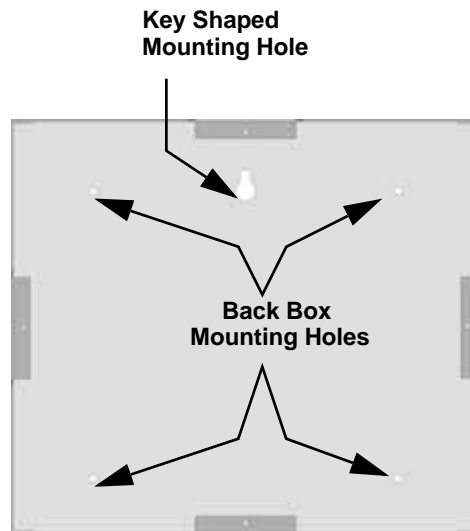

Figure 4-12 Back Box Surface Mount Holes

3. Run wires to the control panel.
4. Place the trim ring over the back box as shown in Figure 4-13.

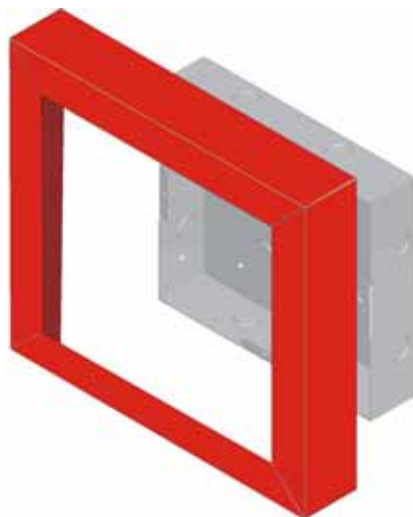

Figure 4-13 Installing Trim Ring

5. Attach the Door assembly to the back box using screws provided.
6. After the annunciator wiring to the panel has been completed (described in Section 4.6.2), replace the electronic assembly in the back box. Place the bezel over the back box and tighten the set screws on the bezel.

4.6 RA-1000 Remote Annunciator Installation

The optional Model RA-1000 is a remote annunciator that utilizes a fireman's key or access code to reset or silence. Up to 8 annunciators can be added to the IFP-100 system.



Figure 4-14 Model RA-1000 Remote Annunciator, Front View

RA-1000 installation involves the following steps:

1. Make sure power is off at the panel.
2. Mount the RA-1000 in the desired location (see Section 4.6.1).
3. Connect the RA-1000 to the panel (see Section 4.6.2).
4. Use the dipswitches on the back of the RA-1000 to assign an ID# to the RA-1000 (see Section 4.10.1).
5. The new RA-1000 module must be added to the system through programming. JumpStart will add the module automatically (see Section 6.1). You can also add it manually (see Section 7.3.2). Select a name, if desired (see Section 7.3.1.1).

4.6.1 Mounting the RA-1000

This section of the manual describes mounting the remote annunciator. The annunciator can be flush- or surface-mounted.

Figure 4-15 shows the parts of the annunciator. Instructions for disassembling and mounting appear on the following pages.

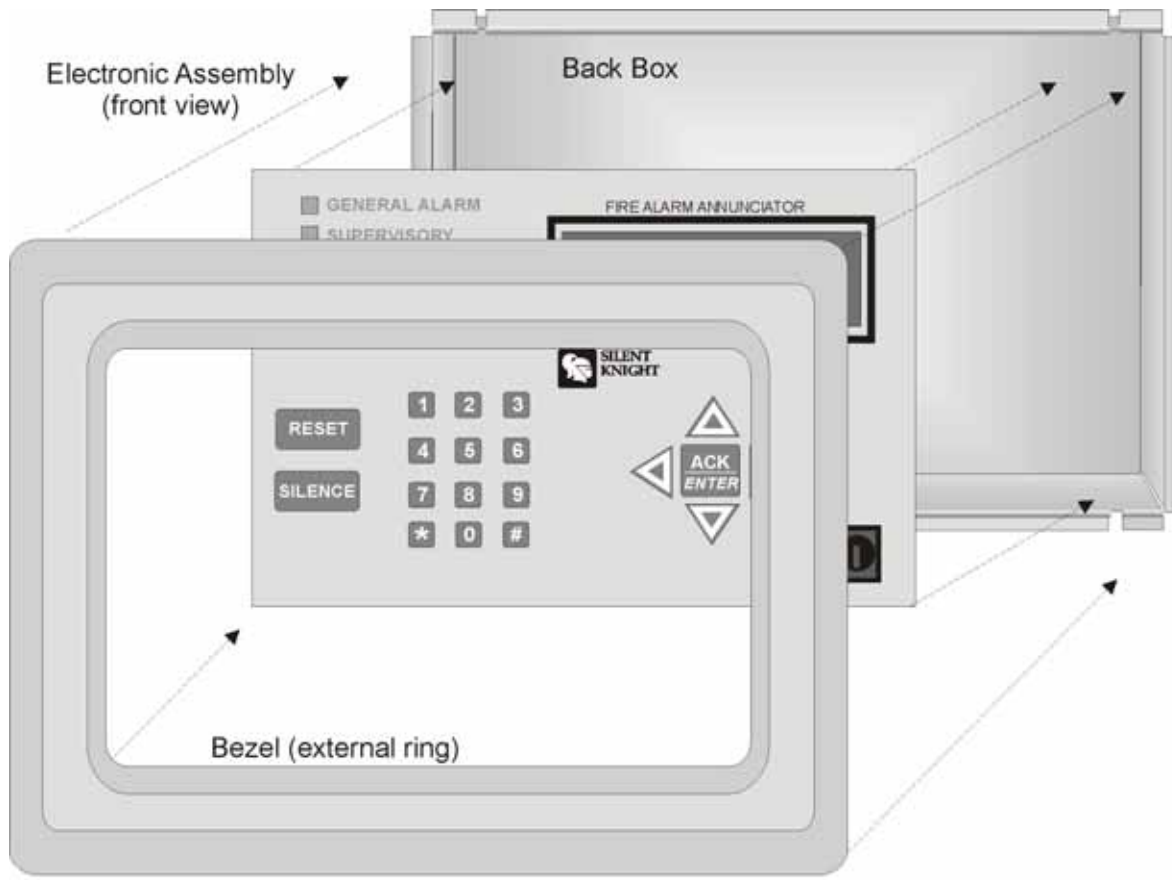

Assembled annunciator also includes mounting wires and 4 set screws.

Figure 4-15 Annunciator Parts

The RA-1000 comes from the factory fully assembled. You must disassemble it for mounting. To disassemble the annunciator, use a 5/64 hex wrench to remove the set screws, located on the bottom of the annunciator bezel. (See Figure 4-16 for location of the set screws.)

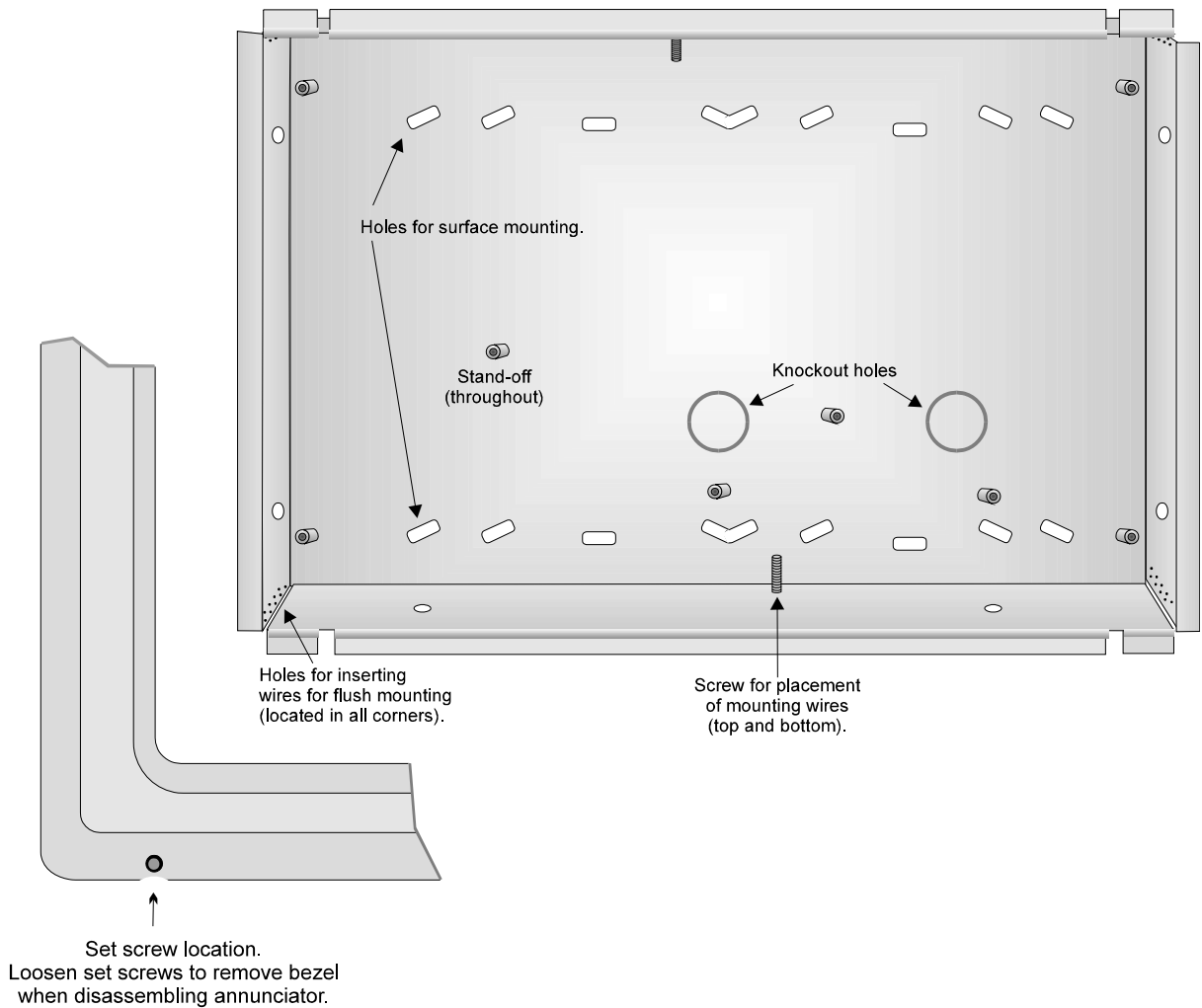

Figure 4-16 Annunciator Back Box and Bezel Details

4.6.1.1 Flush Mounting

This section of the manual describes flush mounting. You can flush-mount with or without an electrical box.

Flush Mounting with an Electrical Box

The RA-1000 annunciator can be used with the following types of electrical boxes: 4S, single-gang, and double-gang.

If an electrical box is used, the box must be 1-3/8" back from the face of the wall to accommodate the annunciator. Studs used with an electrical box must be two by fours (or larger).

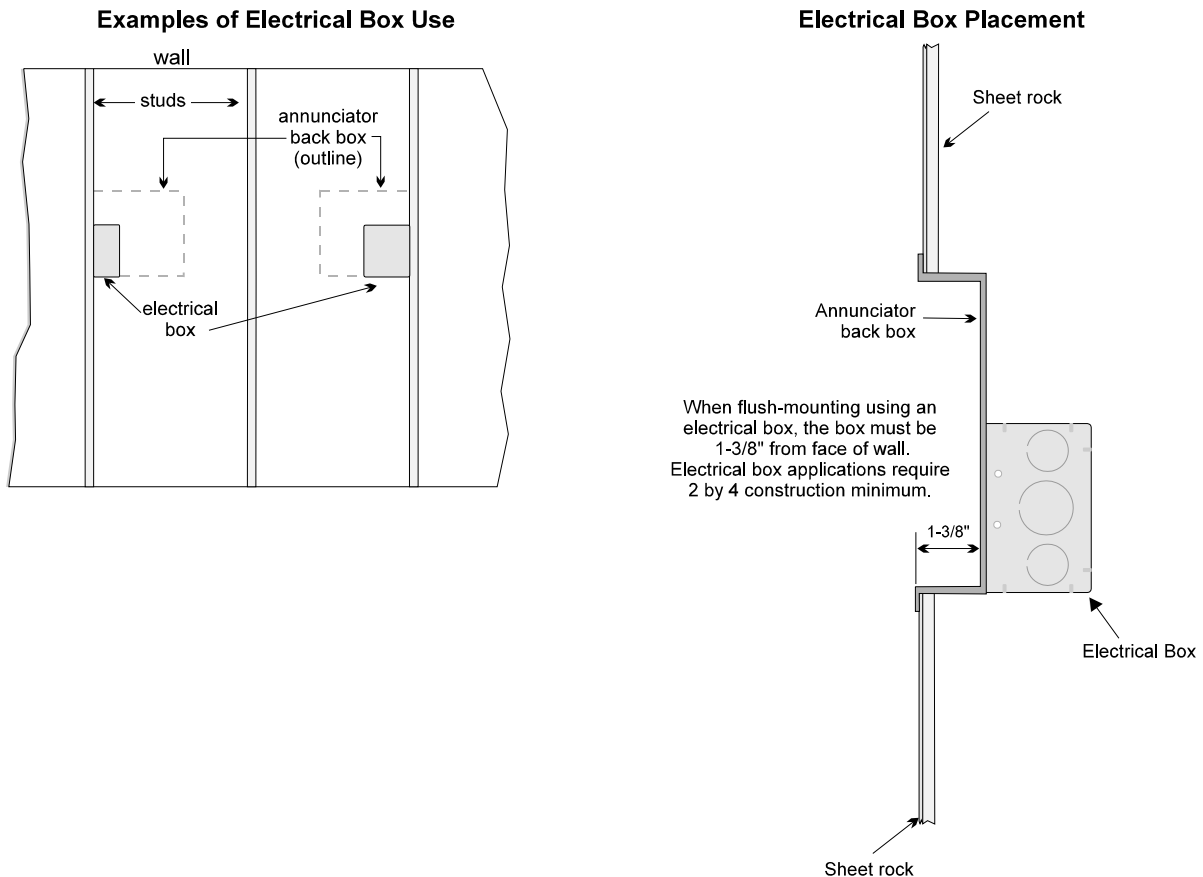

Figure 4-17 Placement of Electrical Box for Flush Mounting

Flush Mounting Steps

1. Cut a hole in the sheet rock to the following dimensions: 8-1/4" w x 6-5/8" h. If an electrical box is used, the box must be 1-3/8" back from face of wall to accommodate the annunciator (see Figure 4-17).
2. Remove knockout holes as needed for wires.
3. Fit the annunciator back box into the hole and stabilize with mounting wires. Angle the mounting wires into the first hole past the sheet rock. Secure the wires behind the screws as shown in Figure 4-18. When all four wires are in place, the back box should fit snugly into the hole in the sheet rock.

4. After the annunciator wiring to the panel has been completed (described in Section 4.6.2), replace the electronic assembly in the back box. Place the bezel over the back box and tighten the set screws on the bezel.

Attach second set of wires to top of back box.

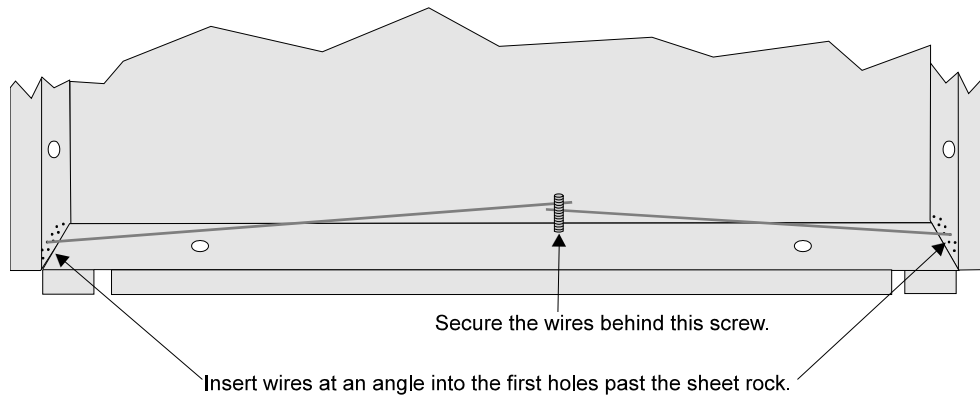

Figure 4-18 Flush Mounting the Back Box

4.6.1.2 Surface Mounting

The RA-1000 can be mounted directly to a surface or can be attached to a single, double, or four-square electrical box. The Model RA-1000TG/TR trim ring kit is available for use when surface mounting.

1. Drill holes in the surface to match the screw holes on the back box.
2. Fit the trim ring over the back box.
3. Attach the back box to the surface using screws provided.
4. After the annunciator wiring to the panel has been completed (described in Section 4.6.2), replace the electronic assembly in the back box. Place the bezel over the back box and tighten the set screws on the bezel.

4.6.2 Connecting the RA-1000 to the Panel

Connect the RA-1000 to the panel as shown in Figure 4-19.

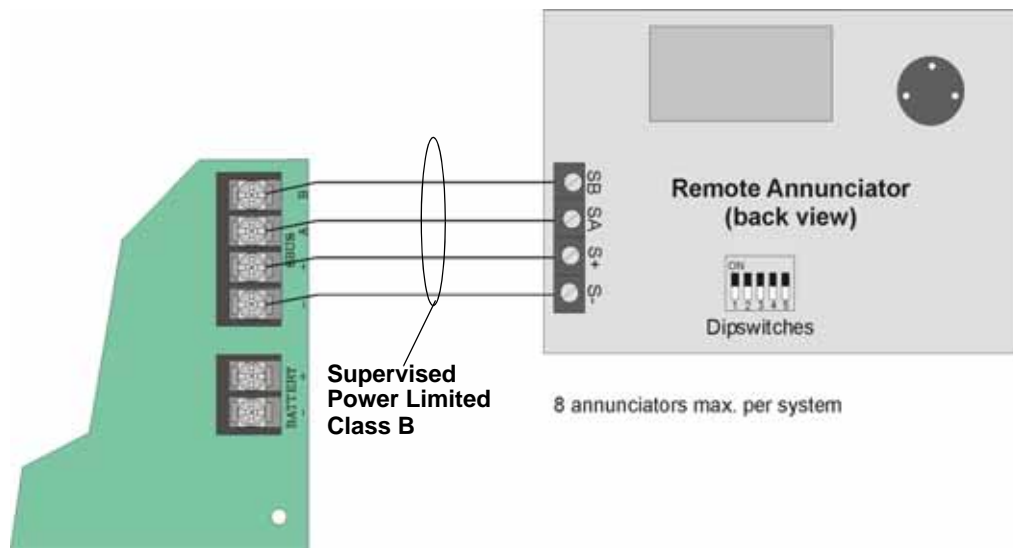

Figure 4-19 Model RA-1000 Connection to the Panel

4.7 5824 Serial/Parallel Printer Interface Module Installation

The 5824 serial/parallel printer interface module allows you to connect a printer to the panel, so you can print a real-time log of system events, a report of detector status, and event history. Instructions for installing the 5824 appear below.

The 5824 and the printer connected to the 5824 are for ancillary use only. The printer must be a UL 864 listed printer.

To install the 5824:

1. Make sure power is off at the panel.
2. Connect the 5824 to the panel as shown in Figure 4-20.

Note: Two 5824s per panel maximum.

3. Use the dipswitches on the back of the 5824 board to assign an ID# to the 5824 (see Section 4.10.1).
4. Configure the 5824 device through programming. See Section 4.7.1.

5. Connect a printer to the 5824 as shown in Figure 4-21.

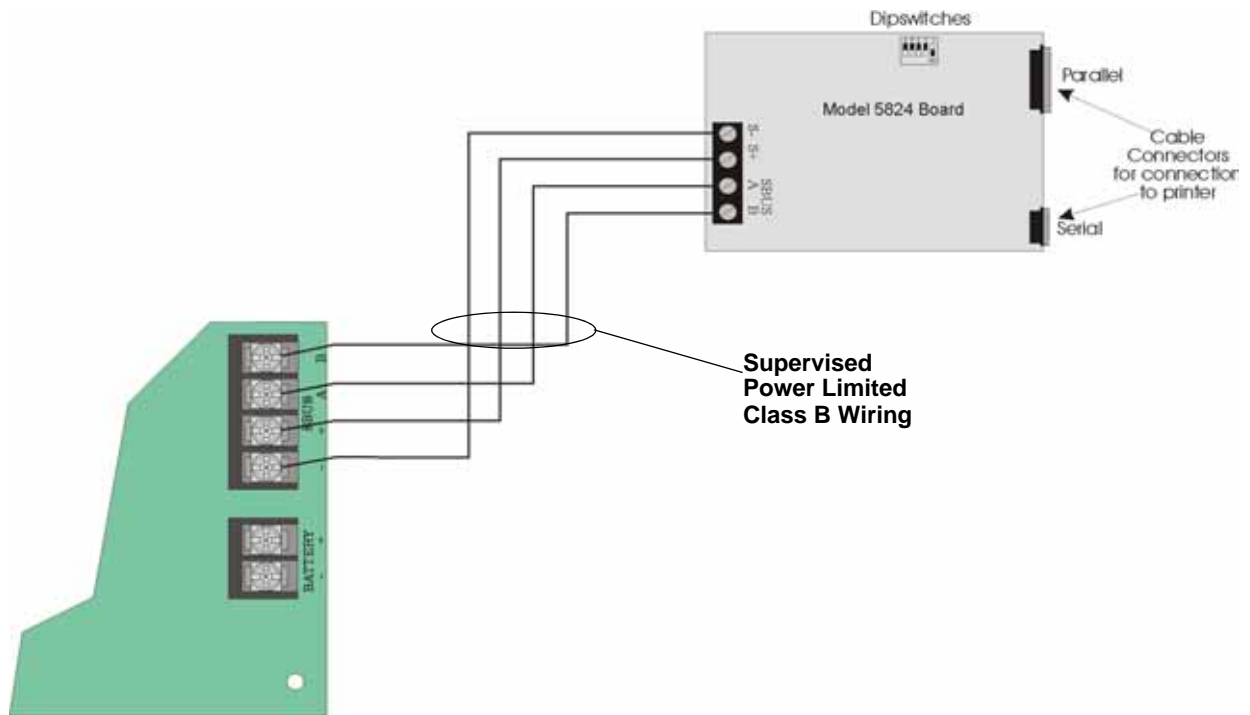

Figure 4-20 5824 Connection to the Panel

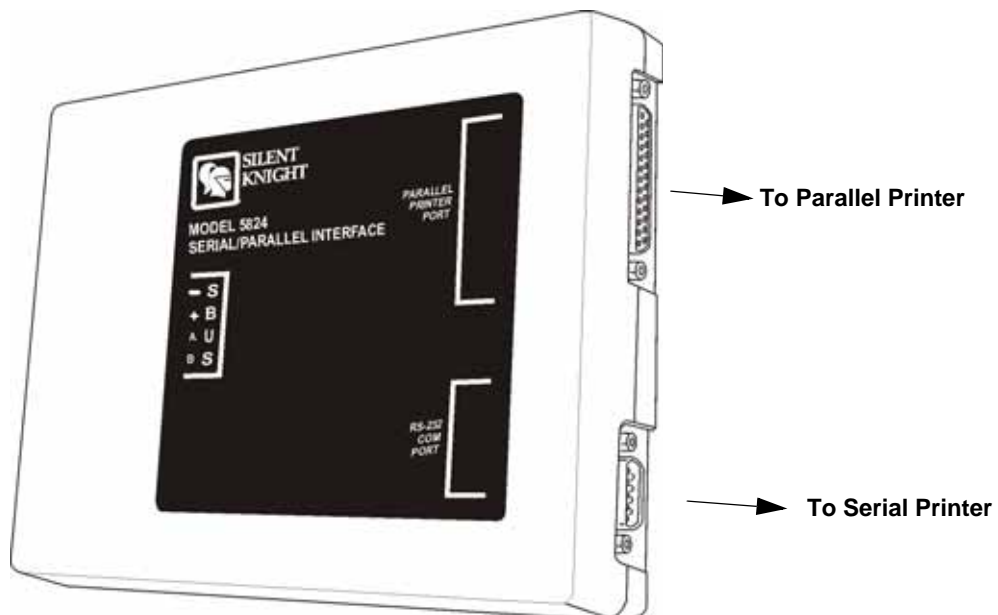

Figure 4-21 Printer Connection

4.7.1 Selecting 5824 Options

Configuring the 5824 includes the following steps:

- Add the module to the system. JumpStart will add the module automatically (see Section 6.1). You can also add it manually (see Section 7.3.2).
- Select a name, if desired (see Section 7.3.1.1).
- Select options for the printer and the output port. See below.

Printer and Output Port Options

The printer is for ancillary use only.

1. From the Main Menu, select **7** for Program Menu.
2. Select **1** for Module.
3. Select **1** for Edit Module.
4. From the list that displays, select the 5824 module you want to configure.
5. Press **ENTER** **ENTER** to bypass the next two screens. A screen similar to the one shown in Figure 4-22 will display.

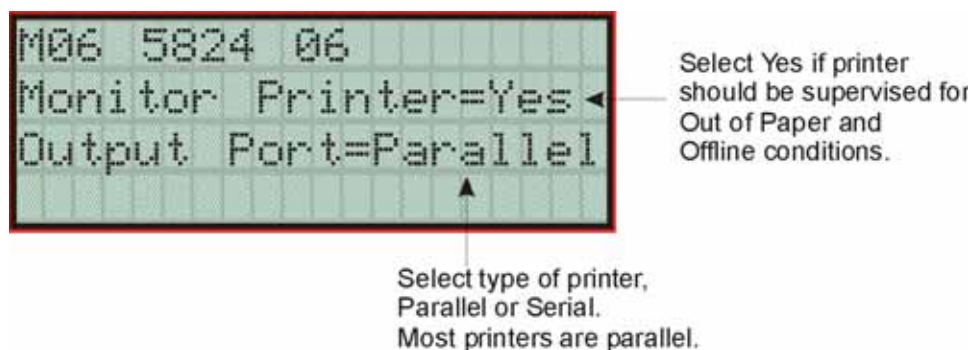

Figure 4-22 Selecting Printer and Output Port Options

6. Select options for the printer as needed for your installation. Most printers are parallel.
7. If you are using a serial printer, use the next screen to select serial port options as required for your printer. Refer to your printer manual if you need more information.

Option	Choices
Baud Rate:	75 - 19200
Data Bits:	5 - 8
Stop Bits:	.5, 1, 2
Parity:	None, Even, Odd

4.8 5880 LED I/O Module

The 5880 is an LED driver board that can be used in a wide variety of applications, including as an interface with most customized floor plan annunciator boards. The 5880 can drive up to 40 LEDs and has one PZT controller. The 5880 also has eight inputs for dry contact monitoring. The following sub-sections describe hardware installation. Refer to Section 6 for programming information.

4.8.1 5880 Board Layout

Figure 4-23 is a picture of the 5880 board showing locations of screw terminals for connection to the panel and contact monitor wiring; pin connectors for connecting LEDs; and the dipswitch for selecting an SBUS ID number.

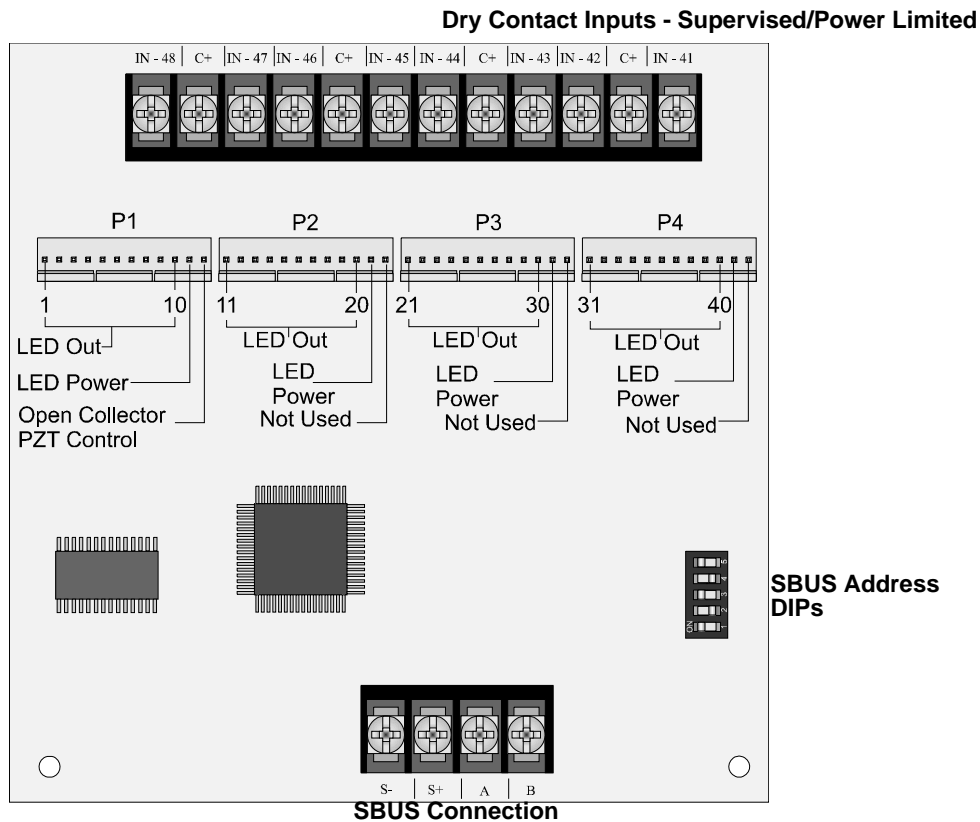

Figure 4-23 5880 Board Layout

4.8.2 FACP Connection

The 5880 connects to the panel via the SBUS. Make connections as shown in Figure 4-24. After the 5880 is connected to the panel, it must be added to the system. This programming step is described in Section 4.10.

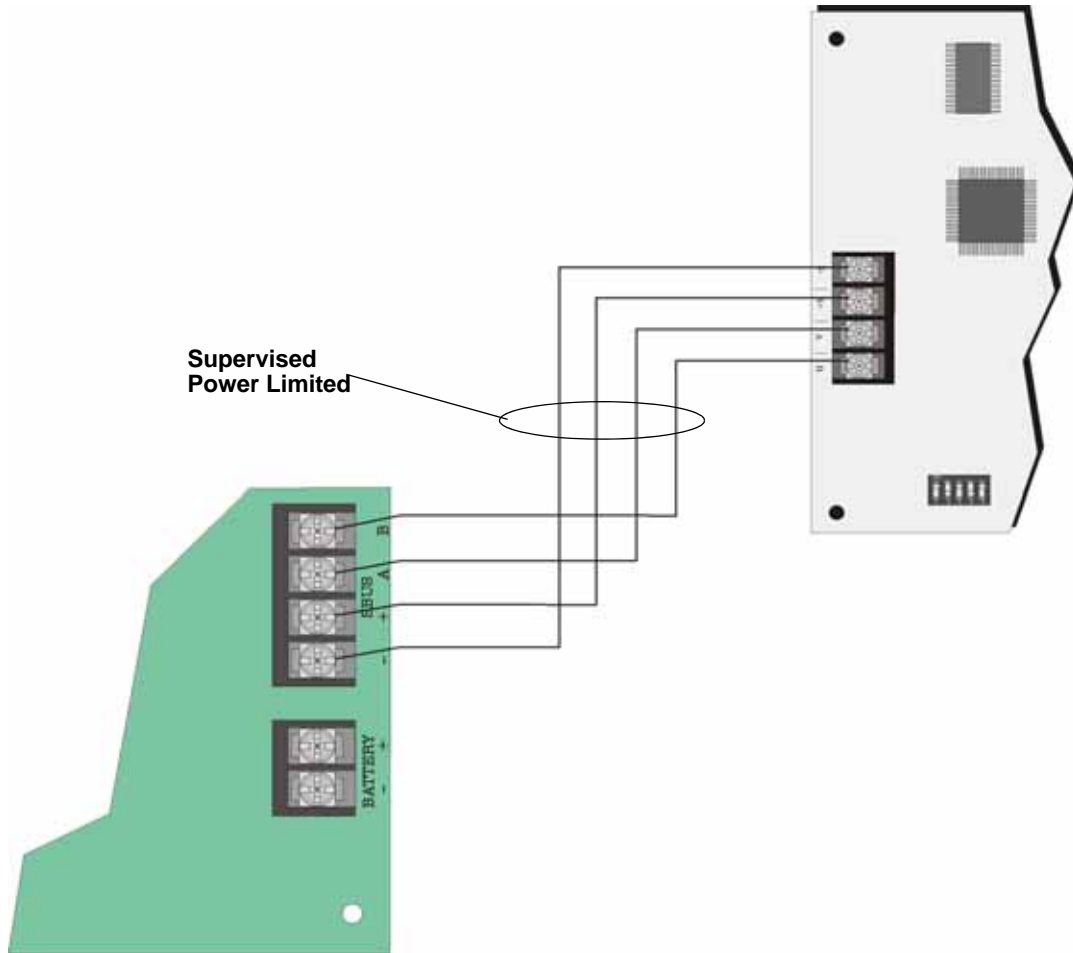

Figure 4-24 5880 Connection to Main Control Panel Assembly

4.8.3 LED Wiring

There are four 12-pin connectors on the 5880 board for connecting LEDs. Each LED gets its power from Pin 11. Internal resistors are sized so that there is approximately 10 mA of current for each LED, no series resistors are required. LED outputs can be mapped to output circuits. See Section 6 for programming details.

Wire the LEDs as shown in Figure 4-25.

On connector P1, Pin 12 is a common open collector output for controlling a PZT. If used, the 5880 PZT will match the PZT pattern of the on-board (or RA-1000) annunciator.

Note: The circuit connected to common “Open Collector Output” (last pin on P1) must be current limited so that no more than 100 mA of current is allowed to flow into the open collector transistor.

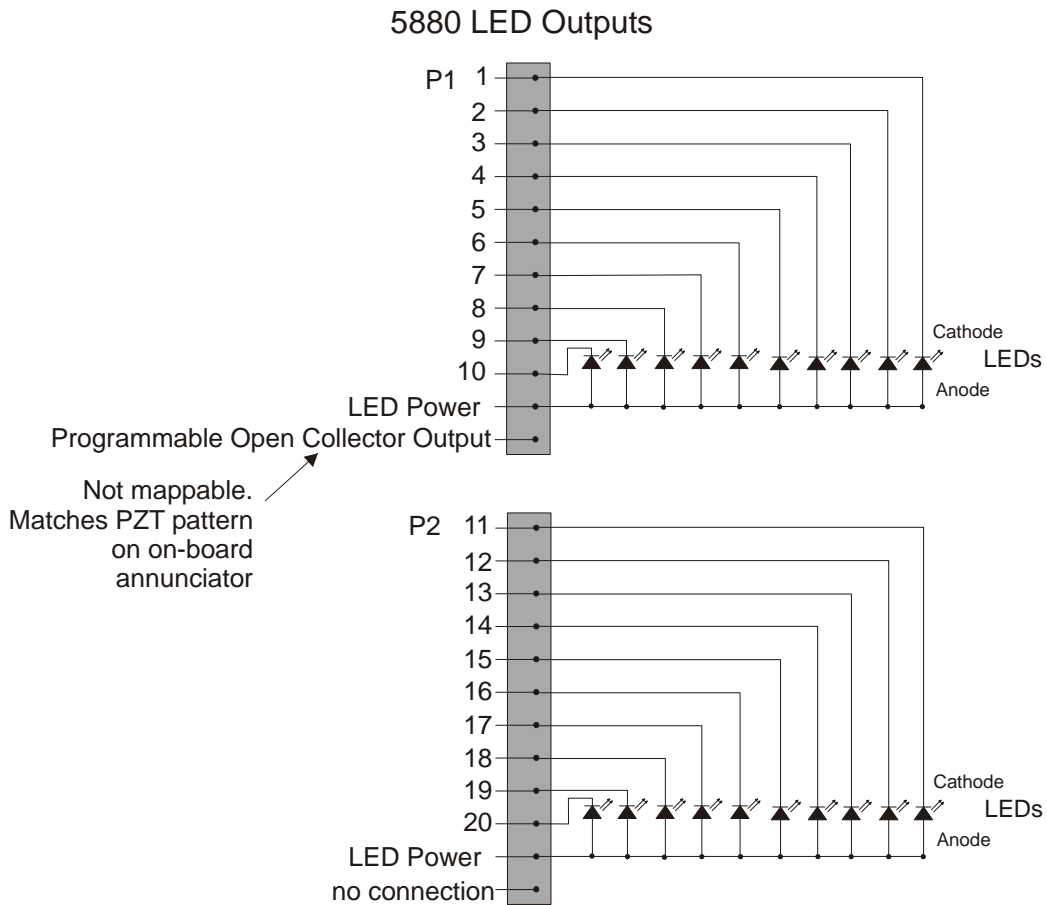

Connectors P3 and P4 wired same as P2.

Figure 4-25 5880 Board Layout

4.8.4 Dry Contact Wiring

The 8 input circuits on the 5880 board are for monitoring switch inputs-any type of switch supported by the control panel can be used with the 5880. For example, you can use a 5880 to monitor pull stations, water flow, tamper, reset, or silence switches.

Wire dry contacts as shown in Figure 4-26. Notice grouping of terminals; power terminals are shared by two inputs.

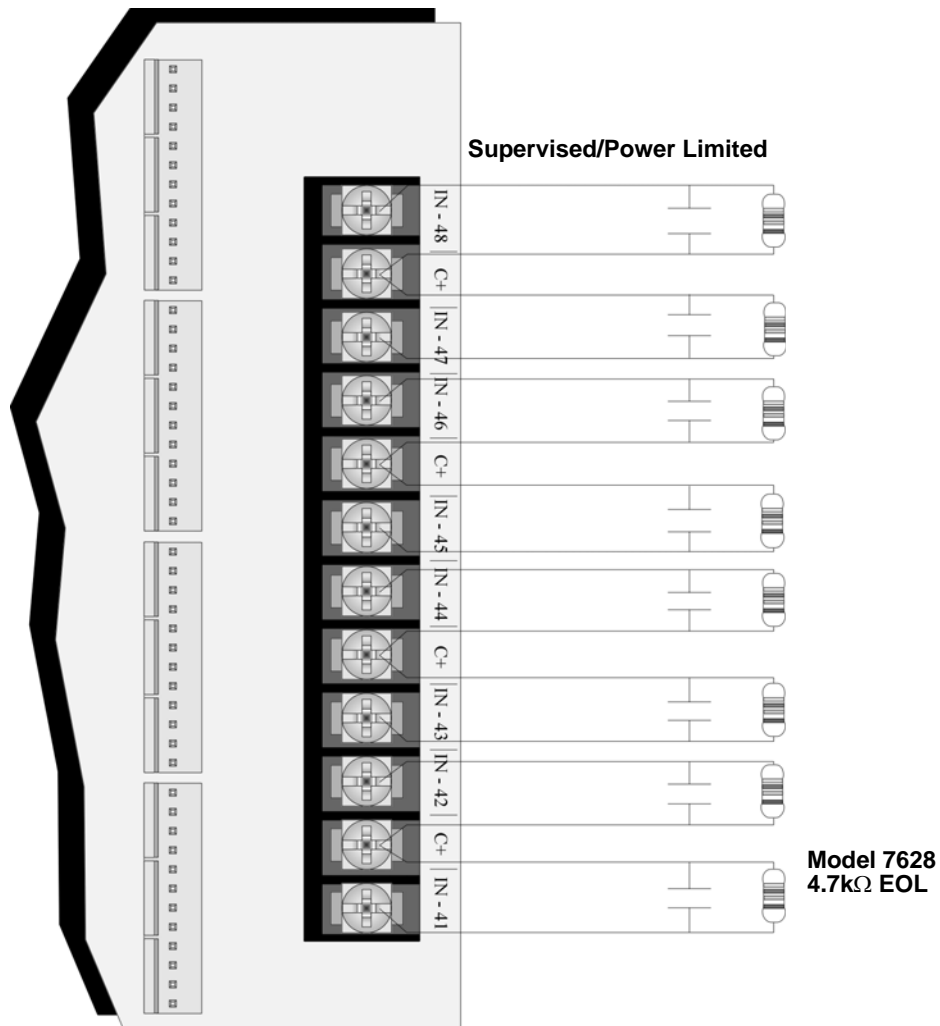

Figure 4-26 Dry Contact Wiring

4.9 5865-3 / 5865-4 LED Annunciator Installation

The 5865-3 and 5865-4 are LED annunciators. The 5865-4 has 30 mappable LEDs, remote silence and reset key switches, and a general system trouble LED. The 5865-3 has 30 mappable LEDs only. These are arranged as 15 pairs of red (typically used for alarm) and yellow (typically used for trouble) LEDs.

Installation of the 5865-3 and 5865-4 is identical. The key switches and the trouble LED follow the behavior of other system annunciators and do not require any installation steps. The following sub-sections describe how to install the 5865-3 and 5865-4 hardware. Refer to Section 6 for programming information.

Note: This manual uses “5865” when referring to aspects of the 5865-3 and 5865-4 that are common to both models.

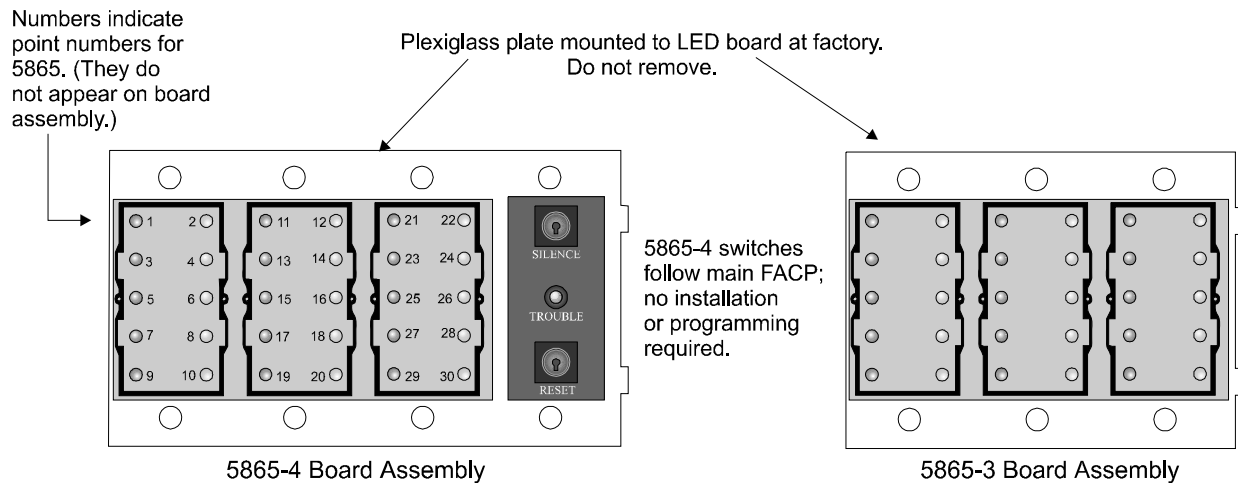

Figure 4-27 5865-3 and 5865-4 Assembly (front view)

4.9.1 FACP Connection

The 5865 connects to the panel via the SBUS. Make connections as shown in Figure 4-28. After the 5865 is connected to the panel, it must be added to the system. This programming step is described in Section 4.10.

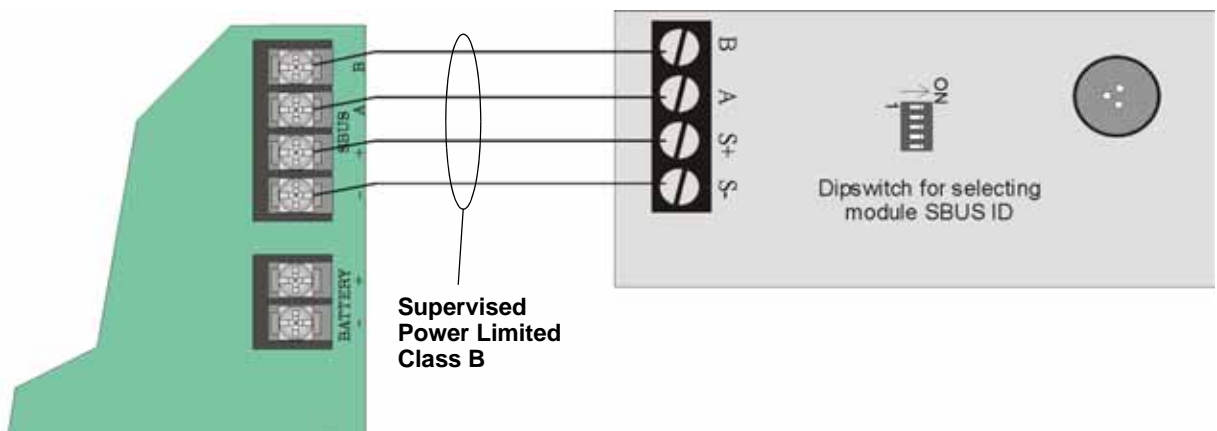

Figure 4-28 5865 Connection to the FACP

4.9.2 5865 Mounting

Mount the 5865-4 to a standard 4-gang electrical box. Mount the 5865-3 to a standard 3-gang electrical box. In Figure 4-29, the 5865-4 attached to a 4-gang box is used as an example.

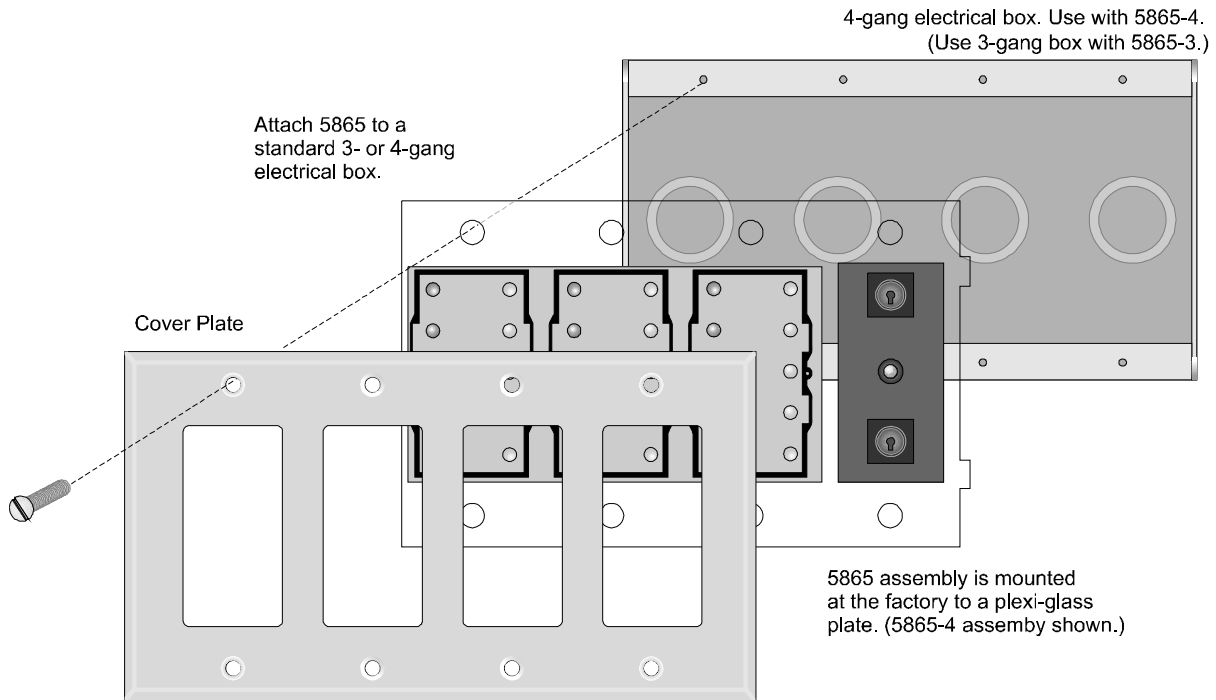

Figure 4-29 5865 Mounting Example

The 5865 ships with a set of zone description labels that can be inserted into the 5865 board assembly. These labels can be used in a typewriter or can be written on by hand.

Slide the labels under the plexiglass as shown in Figure 4-30. The LEDs will show through the label when illuminated.

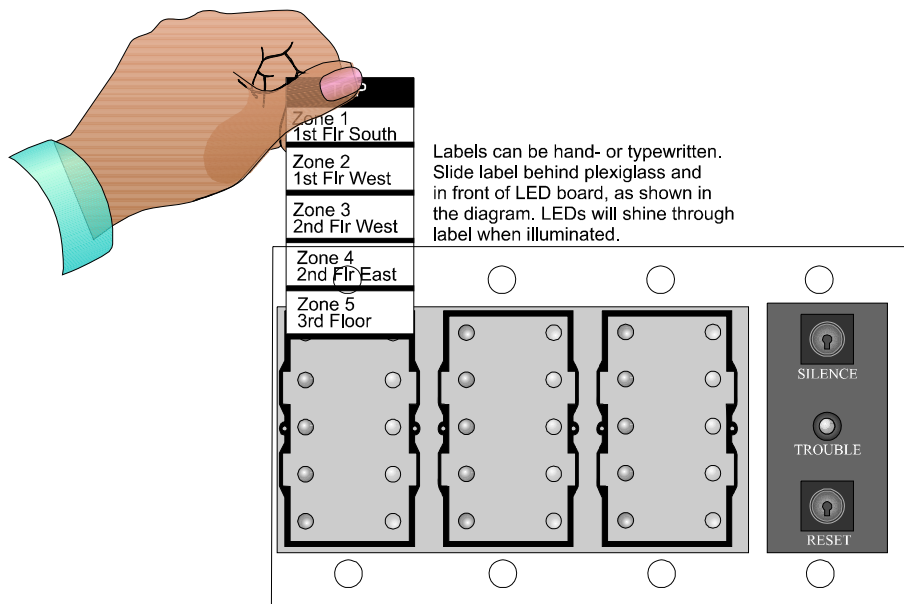

Figure 4-30 Inserting Zone Description Labels

4.10 Configuring Modules

This section describes how to configure any system hardware modules that have been added to the system.

4.10.1 Assigning Module IDs

When installing a hardware module (such as, 5824, RA-1000, RA-100, 5496, RPS-1000, 5865-3 or 5865-4), you must use the dipswitches on the module to assign an ID# to the module.

Figure 4-31 shows all possible dipswitch positions and their correlation to a numerical ID. For example, to select ID 2, place dipswitch 2 in the up position.

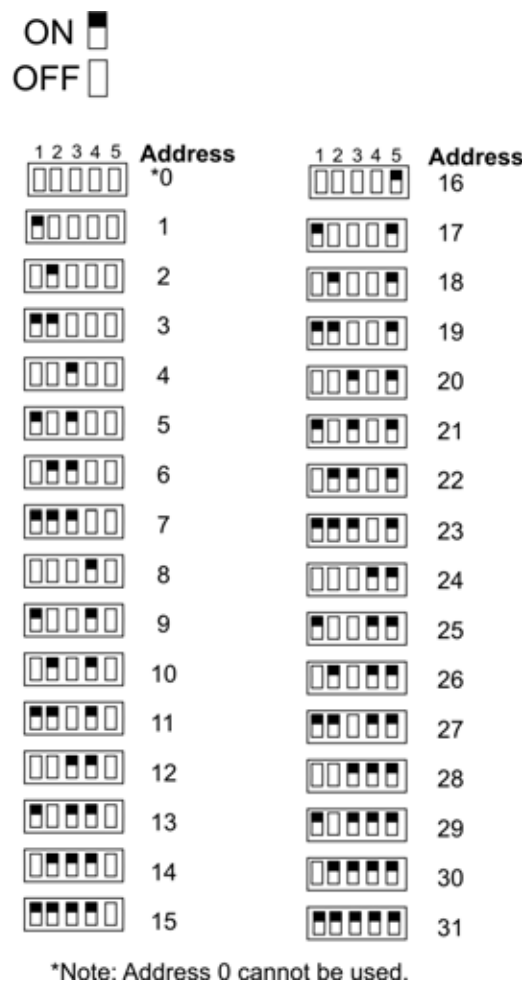

Figure 4-31 Possible module addresses

Refer to Section 7.3 to edit, add, delete, and view module list.

4.11 Telephone Connection

Connect the telephone lines as shown in Figure 4-32. The Model 7860 phone cord is available from Silent Knight for this purpose.

A number of programmable options are available for customizing telephone lines. These options are described in Section 7.7.

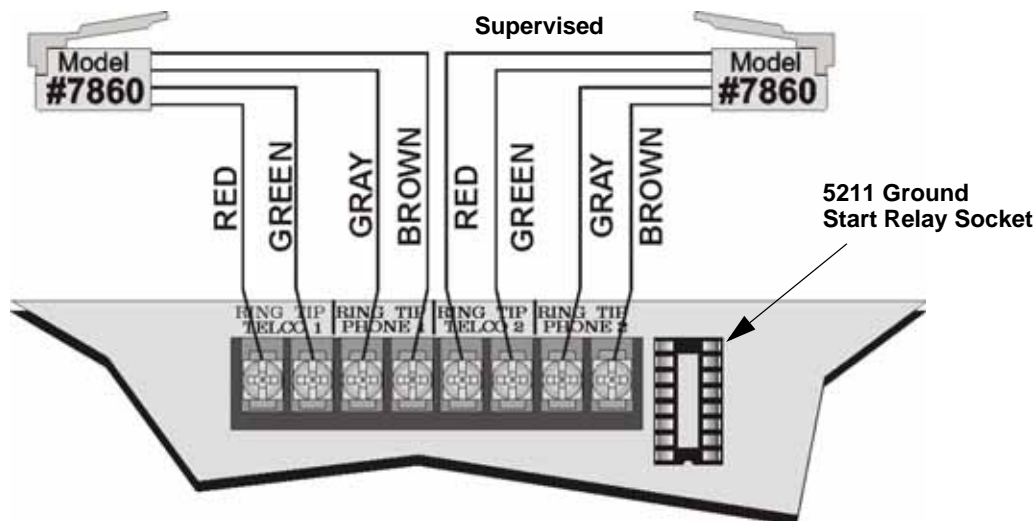

Figure 4-32 Connection of Telephone Lines

4.12 5211 Ground Start Relay

Note: Do not use ground start in UL installations.

If connecting the control panel to a ground start telephone network, you must use the 5211 ground start relay (order separately).

To install the 5211:

1. Install the 5211 on the ground relay socket as shown in Figure 4-32.
2. Enable ground start through the ground start programming option as described in Section 7.7.2.6.

4.13 Notification Appliance/Auxiliary Power Circuits

Note: These circuits are considered regulated unless used for releasing type service, in which case they are considered special applications.

Four outputs are built-in to the IFP-100 FACP which can be programmed to be used as NACs (Class A or Class B) or as Aux power.

This section of the manual explains how to install conventional notification appliances and how these terminals can be used for auxiliary power.

4.13.1 Conventional Notification Appliance

This sub-section of the manual explains how to install conventional notification appliances for Class A (Style Z) and Class B (Style Y) configurations.

4.13.1.1 Class B Notification Wiring

You must use an appliance from the list of compatible appliances in Appendix A.

To install a Class B notification appliance circuit:

1. Wire Class B Notification appliances as shown in Figure 4-33.
2. Configure the circuit through programming (see Section 7.6).

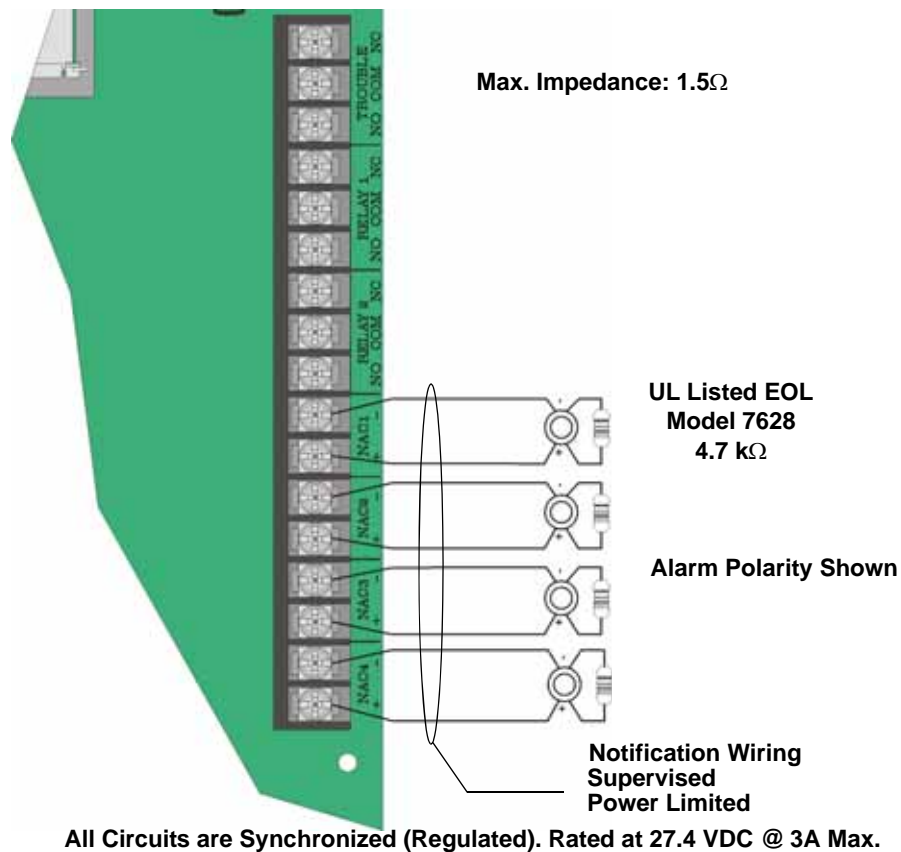

Figure 4-33 Class B Notification Appliance Circuit Wiring

4.13.1.2 Class A Notification Wiring

You must use an appliance from the list of compatible appliances in Appendix A.

To install a Class A notification appliance circuit:

1. Wire the Class A notification appliances as shown in Figure 4-34.

Caution

For proper system supervision do not use looped wire under terminals marked + and - of the Flexput connectors. Break wire runs to provide supervision of connections.

2. Configure the circuit for Class A in programming (see Section 7.6).

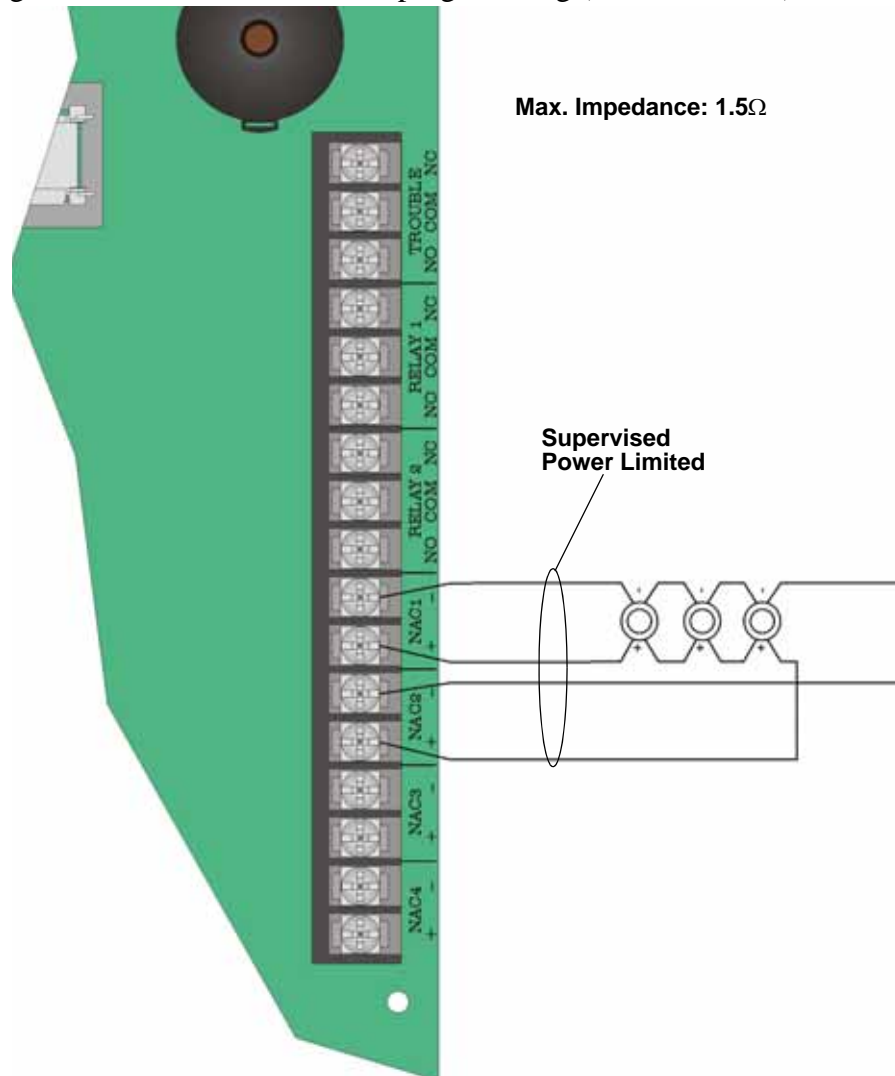

All Circuits are Synchronized (Regulated). Rated @ 27.4 VDC @ 3A Max.

Figure 4-34 Class A Notification Appliance Circuit Configuration

4.13.2 Auxiliary Power Installation

NAC Circuits 1-4 on the control panel can be used as auxiliary power circuits. The three types of auxiliary power available are:

- Door Holder (see section 4.13.2.1)
- Constant (see section 4.13.2.2)
- Resettable Power (see section 4.13.2.3)

Auxiliary power circuits are power limited. Each circuit can source up to 3A (total current for all NAC circuits must not exceed 6A).

To install an auxiliary power circuit:

1. Wire the NAC circuit(s) that will be used for auxiliary power. See Figure 3-2 for location of NAC circuits.
2. Configure the auxiliary power output through programming (see section 7.6).

4.13.2.1 Door Holder Power

Door holder power is intended for fire door applications. When there are no alarms in the system and the panel has AC power, door holder circuits have 24-volt power present at their terminals. Any alarm will cause power to disconnect. Power will be re-applied when the system is reset. If AC power is off for more than 15 seconds, the auxiliary door holder power will be disconnected to conserve the battery backup. When AC power is restored, power is immediately restored to the door holder circuits.

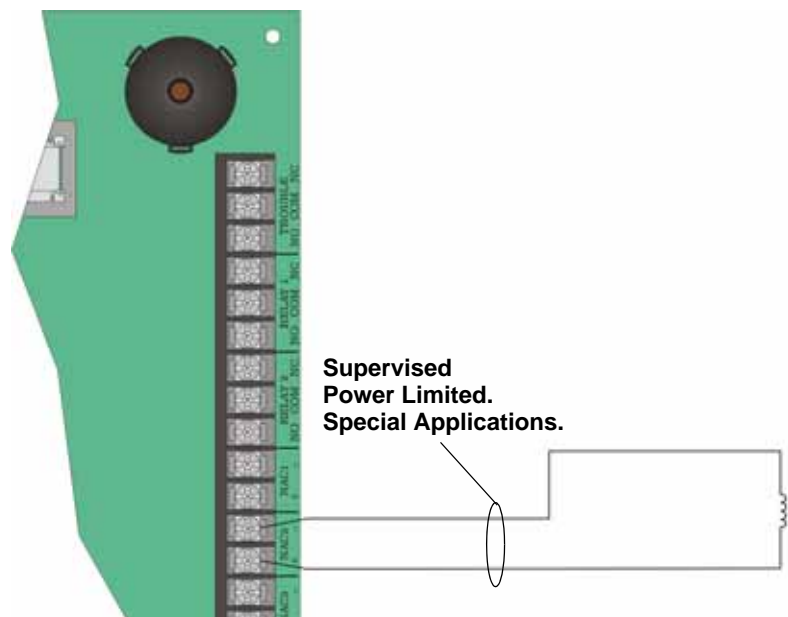

Figure 4-35 Example of an Auxiliary Power For Door Holder

Note: Figure 4-35 uses UL listed door holder Model 1400 from Door Control International as an example.

4.13.2.2 Constant Power

Use constant power for applications that require a constant auxiliary power source. Power is always present at Constant circuits.

4.13.2.3 Resettable Power

Resettable power is typically used to power beam detectors, flame detectors and conventional 4-wire smoke detectors. For circuits selected as Resettable, 24-volt power is always present at the terminals unless a system reset occurs. If a system reset occurs, power is disconnected from the terminals for 30 seconds, then re-applied.

4.14 On-Board Programmable Relays (Conventional)

The control panel has two built-in programmable relays and a built-in trouble relay. All relays are Form C rated at 2.5 A @ 24 VDC (resistive).

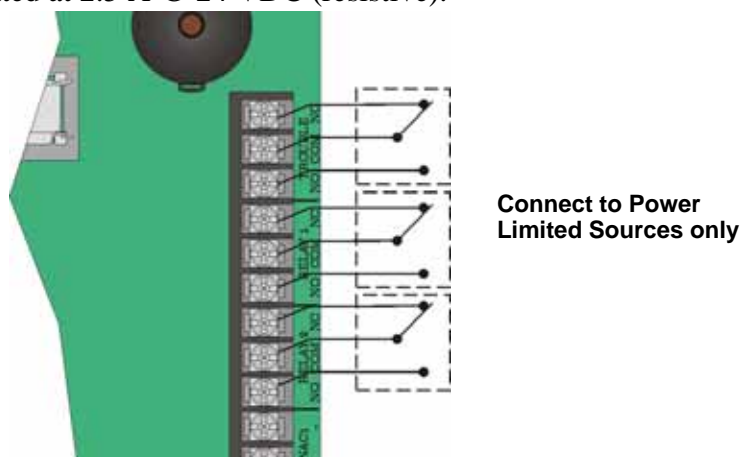

Figure 4-36 Location of Conventional Relay Circuits

Note: The N.C. contact is the relay contact that is closed when the panel has power and there are no alarm or trouble conditions.

4.14.1 Trouble Relay

The control panel has a dedicated common Form C trouble relay built into terminals labeled TROUBLE. The relay provides a normally open and a normally closed contact. The trouble relay will deactivate under any trouble condition.

4.14.2 Programmable Relays

The control panel has two Form C programmable relays built into terminals labeled RELAY 1 and RELAY 2. Each relay provides a normally open and a normally closed contact.

To install one or two programmable relays, follow these steps.

1. Wire Relay 1 and/or Relay 2 as needed for your application. See Figure 4-36 for the location of the relay terminals.
2. Configure the relay through programming (see section 7.6).

4.15 Remote Station Applications

4.15.1 Keltron Model 3158 Installation

The control panel is compatible with Keltron Model 3158, used for direct connection to a Keltron receiver. The 3158 reports alarms, supervisories, and troubles.

The steps for connecting the 3158 to the control panel. Refer to the 3158 installation instructions for complete information.

1. Wire the 3158 to the control panel as shown in the connection list and Figure 4-37.
2. Wire the 3158 within 20 feet of the control panel. Wiring must be enclosed in conduit.
3. Program control panel Relay 2 for alarm.
4. Program NAC circuit 2 for alarm.
5. Program NAC circuit 1 for supervisory non latching.

Note: NACs must be programmed for continuous and non-silencing.

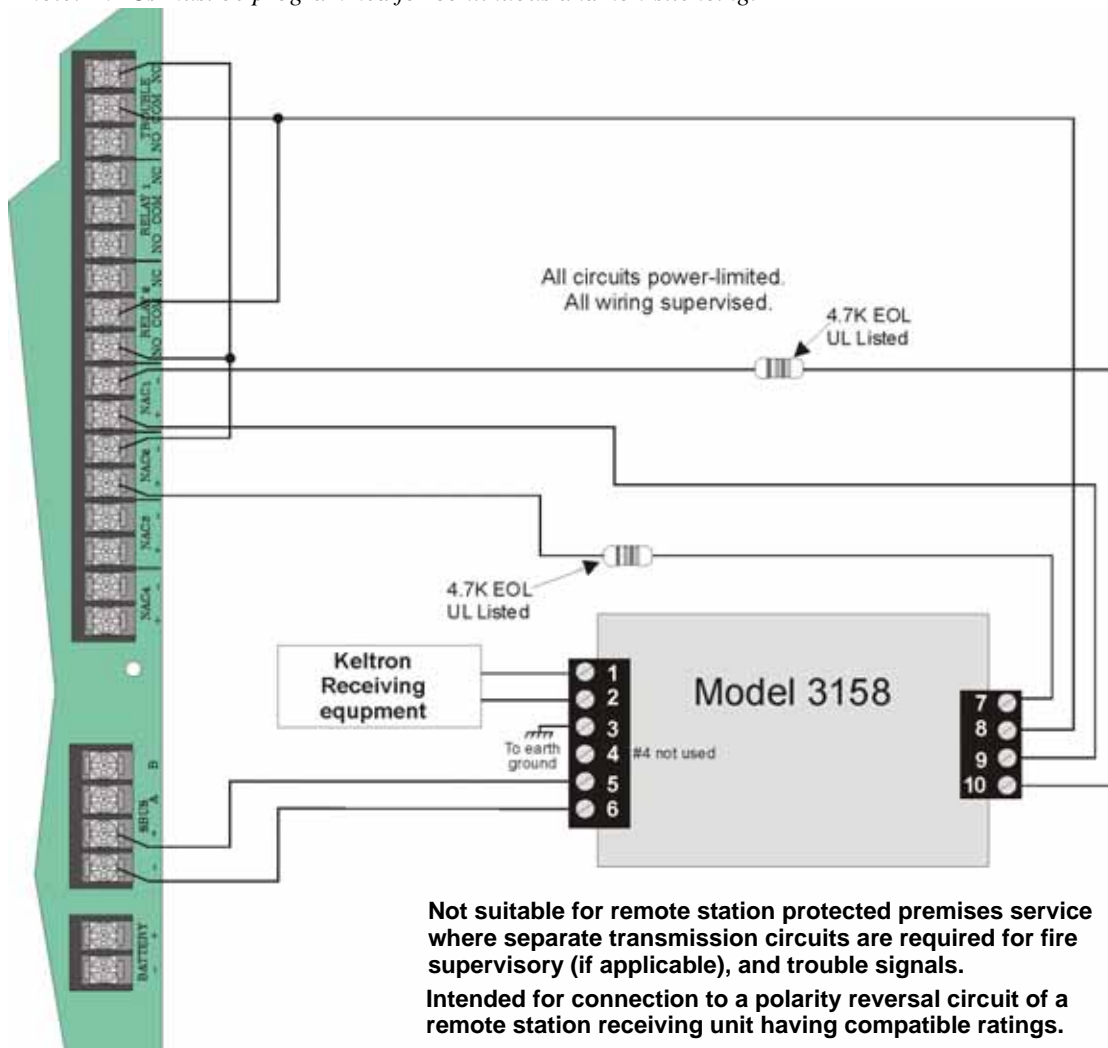

Figure 4-37 Keltron 3158 Connection to Control Panel

4.15.2 City Box Connection Using the 5220 Module

This section describes how to connect the control panel to a municipal fire alarm box or “city box” as required by NFPA 72 Auxiliary Protected Fire Alarm systems for fire alarm service. The city (master) box is an enclosure that contains a manually operated transmitter used to send an alarm to the municipal communication center which houses the central operating part of the fire alarm system.

City Box Standby Current: 0 (Notification supervision current accounted for in control panel draw.)

Alarm Current: 1 Amp for 1 second

The maximum coil and wire resistance (combined) must not exceed 30 ohms.

To install the 5220 for city box connection:

1. Use one of the knockouts on the right side of the control panel to connect the 5220 using a short piece of conduit (must not exceed 20 feet in length).
2. Wire the 5220 to the control panel as shown in Figure 4-38. This drawing also shows how to connect the city box coil to terminals 3 and 4 on the 5220. Do not install an EOL resistor in the terminals of the NAC circuit used for this application.
3. Connect earth ground wire to the 5220 chassis with mounting screw.
4. Program the NAC circuit used as a continuous and non-silencing. Refer to Section 7.5.1 for zone grouping and mapping.

It is not possible to reset the remote indication until you clear the condition and reset the control panel.

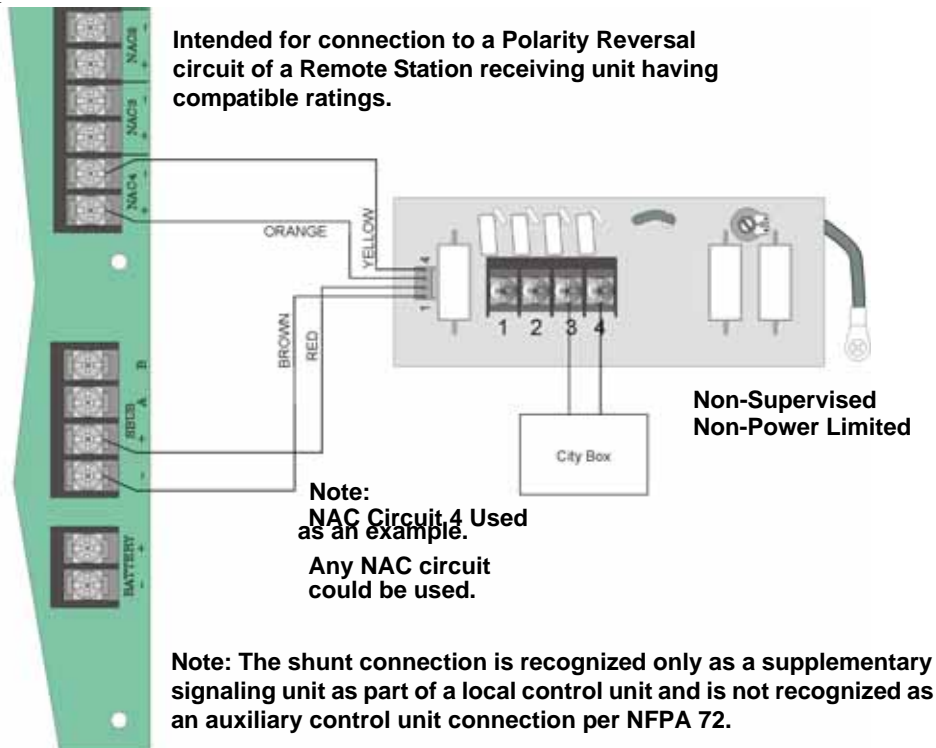

Figure 4-38 City Box Connection

4.15.3 NFPA 72 Polarity Reversal

Note: Intended for connection to a polarity reversal circuit of a control unit at the protected premises having compatible rating.

4.15.3.1 Using the 5220 Module

When the 5220 is wired and programmed for polarity reversal, it reports alarm and trouble events to a remote site. Alarms will override trouble conditions and it will not be possible to reset the remote indicator until the condition is cleared and the control panel is reset.

If an alarm condition occurs, the alarm relay will close, overriding the trouble condition.

Standby Current: 100 mA, 24 VDC

Alarm: 100 mA, 24 VDC

To install the 5220 for polarity reversal, follow the steps below:

1. Locate the knockout on the right side of the control panel cabinet to connect the 5220 using a short piece of conduit (must not exceed 20 feet in length).
2. Wire the 5220 to the control panel using the four-wire pigtail provided as shown in Figure 4-39. This diagram also shows how to connect the 5220 to the remote indicator. Do not install an EOL resistor in the terminals of the NAC circuit used for this application.
3. Connect earth ground wire to the 5220 chassis with mounting screw.
4. Program the NAC circuit used as continuous and non-silencing. Refer to Section 7.5.1 for zone grouping and mapping.

- If necessary, adjust loop current using the potentiometer (R10) on the 5220 board. Normal loop current is 2-to-8 mA with a 1k ohm remote station protected premise unit. Maximum loop resistance is 3k ohm.

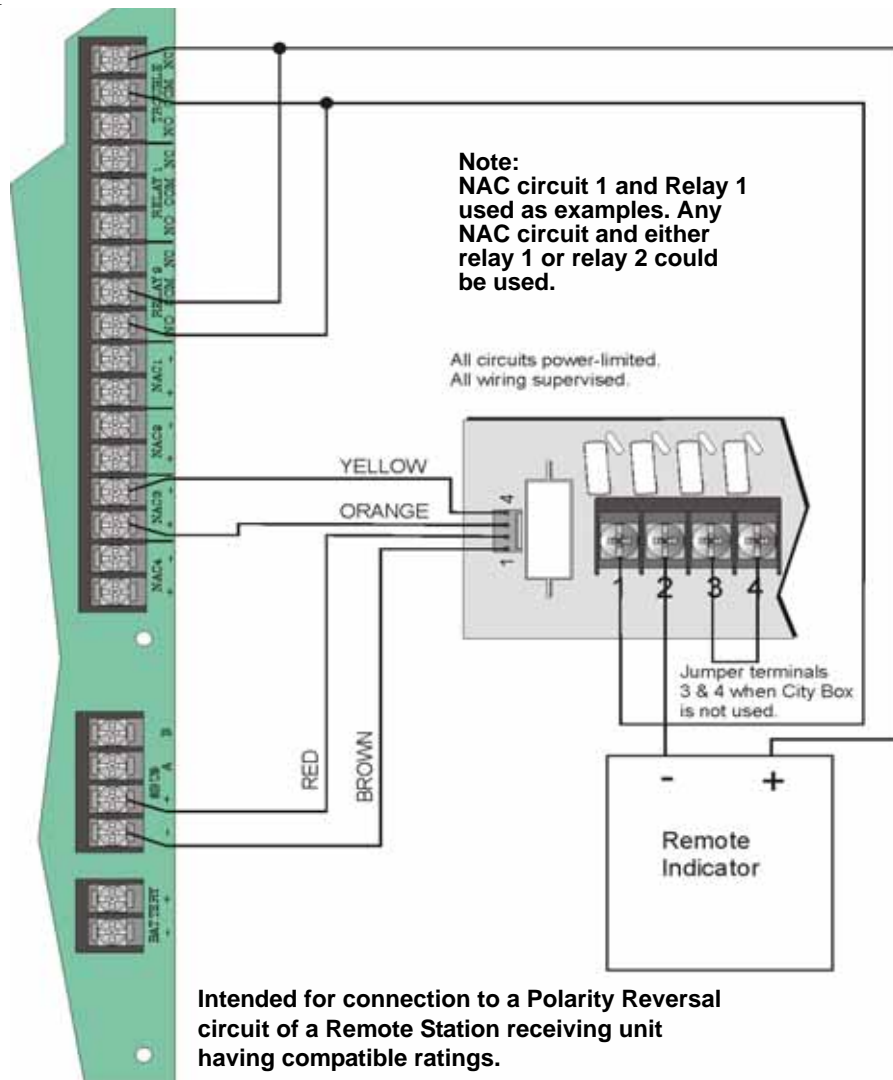

Figure 4-39 Polarity Reversal Connection Using the 5220 Module

4.15.3.2 Using the 7644 Module

When the 7644 is used for polarity reversal, it allows alarm and trouble events to be reported to a remote site. Alarms will override trouble conditions and it will not be possible to reset the remote indicator until the condition is cleared and the control panel is reset.

To install the 7644 for polarity reversal:

1. Wire the 7644 to the control panel as shown in Figure 4-40. Do not install an EOL resistor on the terminals of the NAC circuit used.

Note: Use only NAC circuits on the control panel for reverse polarity.

2. Program the NAC circuit as a notification circuit. See Section 7.6.2.
3. Map the group to activate constant on from the zone event. See Section 7.4.1.3.
4. Program the output group characteristics as non-silenceable and reverse polarity. See Section 7.5.1.2.

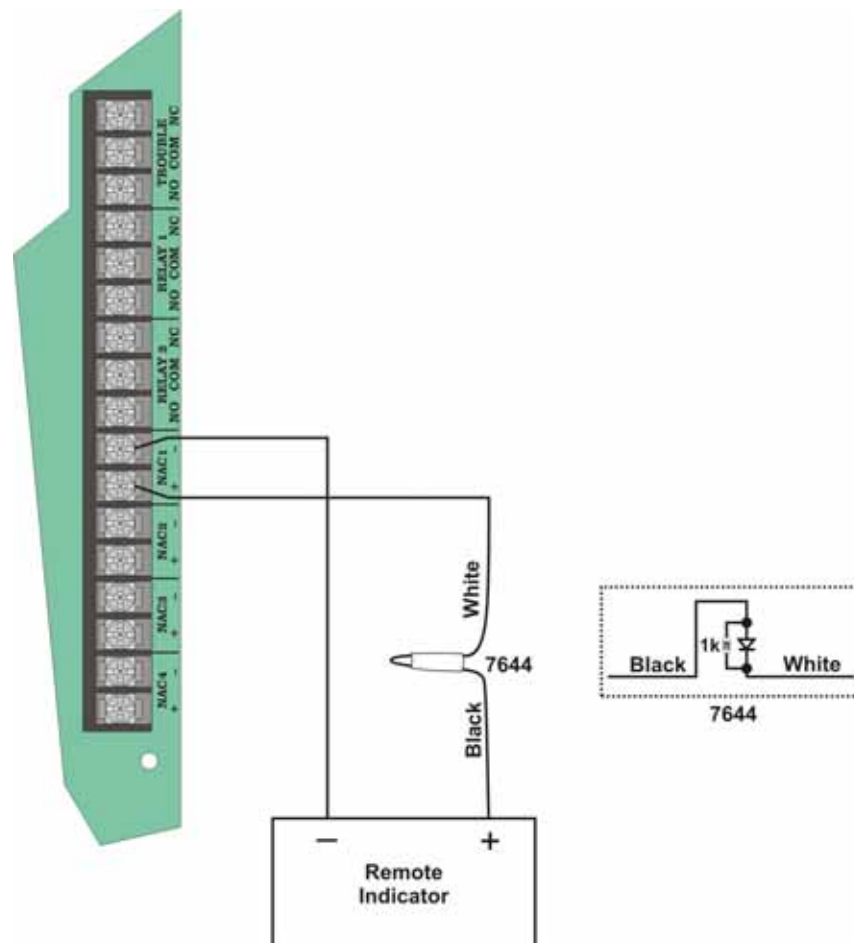

Figure 4-40 Polarity Reversal Connection Using the 7644

4.15.4 Using the SD500-ARM Addressable Relay Module

When the SD500-ARM is wired for polarity reversal, it reports alarm and trouble events to a remote site. Alarms will override trouble conditions and it will not be possible to reset the remote indicator until the condition is cleared and the control panel is reset.

Relay 2 must be programmed for Alarm (default).

Note: If you need to transmit supervisories or trouble conditions, additional SD500-ARM modules must be added. Use relay 1 to transmit supervisory conditions. Use the trouble relay to transmit trouble conditions.

Wire the SD500-ARM as shown in Figure 4-41.

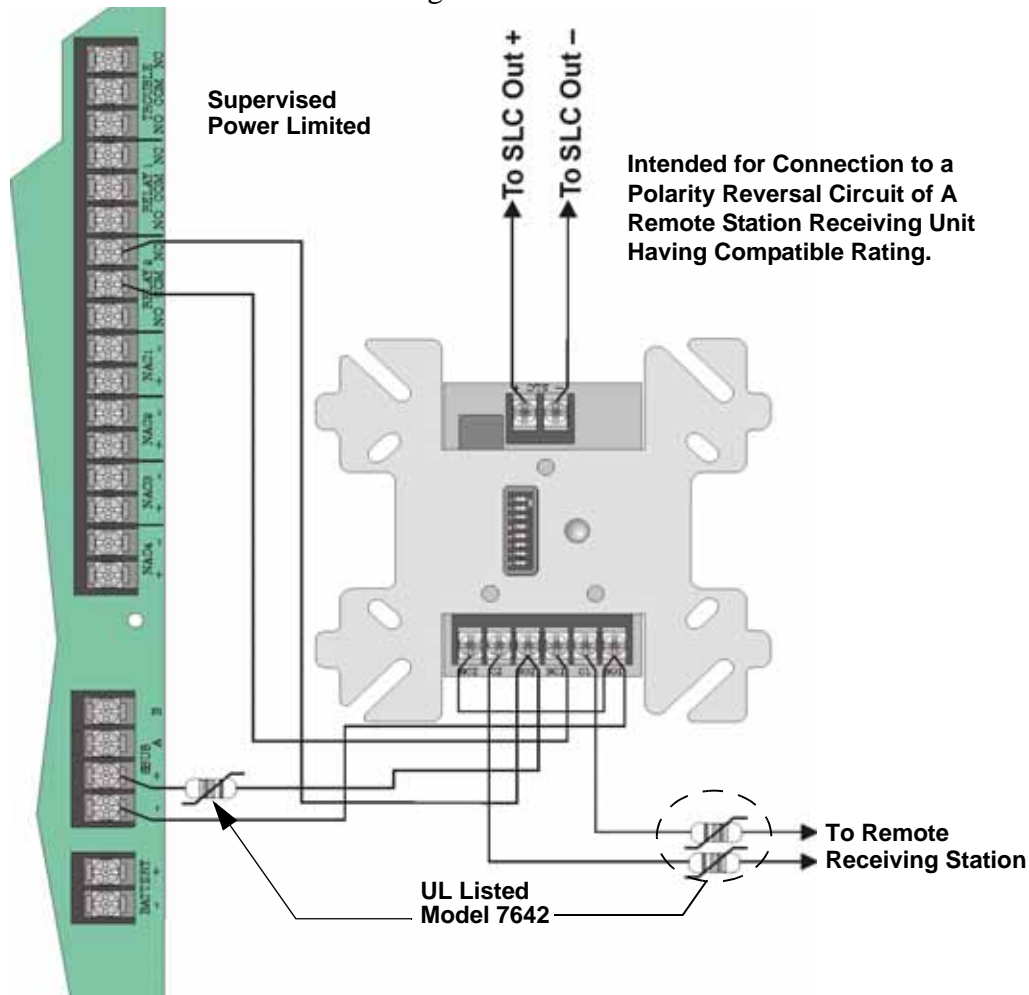

Figure 4-41 Polarity Reversal Connection Using the SD500-ARM Module

4.15.5 Using a MR-201/T Control Relay From Air Products

When the MR-201/T control relay is wired for polarity reversal, it reports alarm and trouble events to a remote site. Alarms will override trouble conditions and it will not be possible to reset the remote indicator until the condition is cleared and the control panel is reset.

If an alarm condition occurs, the alarm relay will close, overriding the trouble condition.

Current:	15 mA max.
Operating Voltage:	24 VDC nominal
Resistance:	4 K Ω

To install the MR-201/T for polarity reversal, follow the steps below:

1. Wire the MR-201/T as shown in Figure 4-42.

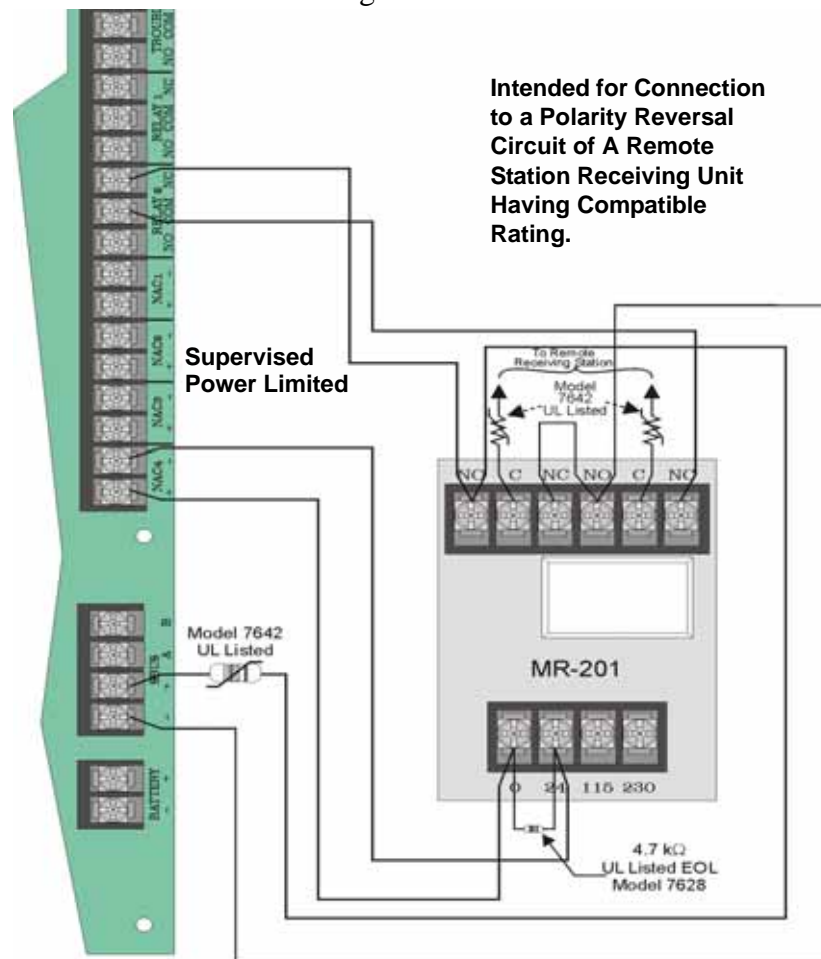

Figure 4-42 Polarity Reversal Connection Using the MR-201/T Relay

2. Program the NAC circuit for non silence NAC circuit (see Section 7.5.1).

Note: If you need to transmit supervisories or trouble conditions, additional relay modules must be added. Use relay 1 to transmit supervisory conditions. Use the trouble relay to transmit trouble conditions.

4.15.6 Transmitter Activated by Dry Contacts

This section describes the connection of a UL 864 listed remote station transmitter to the IFP-100 FACP dry contacts. The FACP contacts must be supervised by the remote station transmitter module using end-of-line resistors (ELRs) with a value determined by the transmitter manufacturer. Power is also provided by the remote station transmitter manufacturer. Refer to the remote station transmitter manufacturer's manual for details.

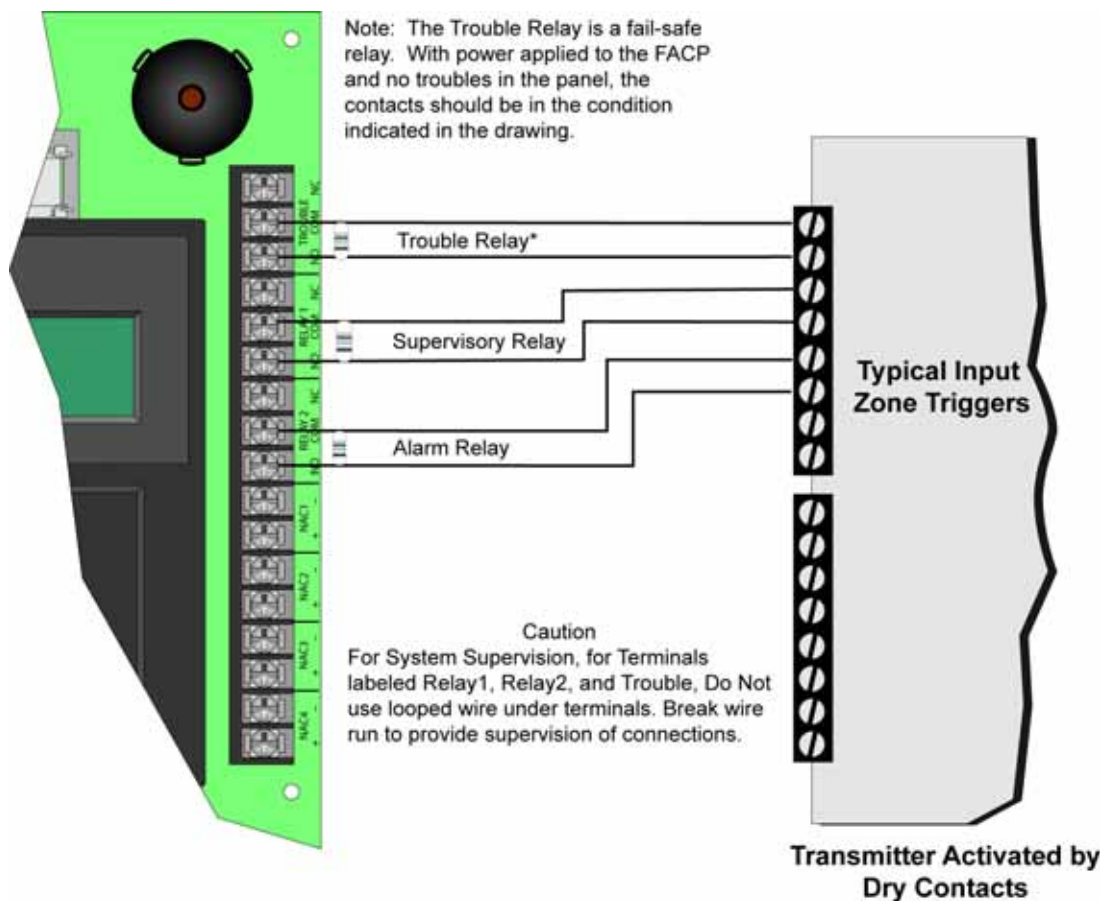

Section 5

IDP and Hochiki SLC Device Installation

Caution!

To avoid the risk of electrical shock and damage to the unit, power should be OFF at the control panel while installing or servicing.

5.1 List of IDP SLC Devices

The following IDP SLC devices can be used with the control panel. See the device installation instructions for more information (packaged with the device).

Note: The control panel supports the use of either IDP SLC devices or Hochiki SLC devices. You cannot install both SLC device types on the control panel.

SK Part Number	Model Name/Description	Section/ Install Sheet PN
IDP-Photo	Photoelectric smoke detector	Section 5.8
IDP-Photo-T	Photoelectric smoke detector with thermal (135°F)	
IDP-Acclimate	Multicriteria photoelectric smoke detector with thermal (135°F)	
IDP-Beam	Reflected beam smoke detector without test feature	K200-18-00
IDP-Beam-T	Reflected beam smoke detector with test feature	
IDP-Ion	Ionization smoke detector	Section 5.8
IDP-Pduct	Photoelectric duct smoke detector with extended air speed range	K200-22-00
IDP-Pduct-R	Photoelectric duct smoke detector with relay and extended air speed range	K200-23-00
IDP-Heat	Fixed temperature thermal detector (135°F)	Section 5.8
IDP-Heat-ROR	Rate-of-rise thermal detector with 135° fixed temperature	
IDP-Heat-HT	Fixed high temperature thermal detector (190°F)	
IDP-Pull-SA	Addressable single action pull station	K200-19-00
IDP-Pull-DA	Addressable dual action pull station	K200-20-00
IDP-Iso	Fault isolator module	K200-21-00
IDP-Monitor	Monitor module	K200-08-00
IDP-Minimon	Mini monitor module	K200-10-00
IDP-Monitor-2	Dual input monitor module	K200-13-00
IDP-Monitor-10	10 input monitor module	K200-14-00
IDP-Relay	Addressable relay module	K200-11-00
IDP-Relay-6	Six relay control module	K200-15-00
IDP-Zone	Addressable zone interface module	K200-12-00
IDP-Zone-6	Six zone interface module	K200-16-00
IDP-Control	Supervised control module	K200-09-00
IDP-Control-6	Six circuit supervised control module	K200-17-00
IDP-6AB	6" mounting base	K200-07-00
SSB224BI (System Sensor PN B224BI)	6" isolator base	D450-15-00
SSB224RB (System Sensor PN B224RB)	6" relay base	D450-16-01
SSB501BHT (System Sensor PN B501BHT)	6" temporal sounder base	D550-06-00
SSB501 (System Sensor PN B501)	4" mounting base	D550-02-00

5.2 List of Hochiki SLC Devices

The following Hochiki SLC devices can be used with the control panel. See the appropriate section number in this manual or the device installation instructions (packaged with the device) for more information.

Note: The control panel supports the use of either Hochiki SLC devices or IDP SLC devices. You cannot install both SLC device types on this control panel.

Model Number	Model Name/Description	Section No./ Installation Instructions PN
SD505-APS	Photoelectric smoke detector.	5.5
SD505-AIS	Ionization smoke detector	5.5
SD505-AHS	Absolute temperature heat detector. Trip point range from 135°F–150°F (0°C–37°C).	5.5
SD505-6AB	6" base for use with the SD505-AHS, SD505-AIS, and SD505-APS.	150955
SD505-6IB	6" short circuit isolator base for use with the SD505-AHS, SD505-AIS, and SD505-APS	151175
SD505-6RB	6" relay base for use with the SD505-AHS, SD505-AIS, and SD505-APS	151192
SD505-6SB	6" sounder base for use with the SD505-AHS, SD505-AIS, and SD505-APS SLC devices	151191
SD505-DUCT	Duct Smoke Detector. Duct Housing including the SD505-APS Analog Photoelectric Smoke Sensor. Intake tubing for duct available in three lengths: SD505-T2 (2.5 foot); SD505-T5 (5 foot); SD505-T10 (10 foot)	1700-09882
SD505-ADH	Duct Detector Housing for use with the SD505-AIS or SD505-APS smoke detectors. Intake tubing for duct available in three lengths: STS-2.5: Duct widths 1.0' to 2.5'; STS-5.0: Duct widths 2.5' to 5.0'; STS-10.0: Duct widths 5.0' to 10.0' When ordering SD505-ADH, specify intake tubing size and order the appropriate smoke detector (if needed).	151040
SD505-ADHR	Duct detector housing with relay (for use with SD505-AIS or SD505-APS smoke detectors)	151126
SD500-PS/-PSDA	Single or dual action addressable pull station	151177
SD500-AIM	Addressable input module (switch input), standard size, dipswitch configurable	151071
SD500-MIM	Mini input monitor module (switch input), small size, dipswitch configurable. Fits in single-gang box with manual pull station switch.	151071
SD500-ANM	Addressable notification module	151109
SD500ARM	Addressable relay module dipswitch configurable.	151091
SD500-SDM	Addressable smoke detector module. Use to assign an address to a loop of conventional devices.	151193
SD500-LIM	Line isolator module. Fits in a double gang box.	151125
SD500-LED	Addressable LED driver module. Capable of driving up to 80 LEDs. Up to 40 SD500-LED Driver Modules can be used per SLC loop.	151232
SD505-DTS	Remote test switch & LED indicator for the SD505-ADHR	151126

5.3 Maximum Number of Devices

The IFP-100 supports IDP or Hochiki devices on one IFP system. The maximum number of devices per system varies depending on device protocol. Device support is as follows:

- IDP Devices—An IFP system can support a total of 99 IDP detectors *and* 99 IDP modules.

OR

- Hochiki Devices—An IFP system can support a total of 99 Hochiki SLC detectors and modules, in any combination.

5.4 Wiring Requirements for SLC Devices

The following information applies to all SLC devices. Refer to the section that describes the type of device you are installing for details.

5.4.1 Wiring 5815XL in Style 4 (Class B) Configuration

No special wire is required for addressable loops. The wire can be untwisted, unshielded, solid or stranded as long as it meets the National Electric Code 760-51 requirements for power limited fire protective signaling cables. Wire distances are computed using copper wire.

Maximum wiring resistance is 40 ohms for IDP device and 50 ohms for Hochiki devices.

Maximum loop length depends on the wire gauge.

Wire Gauge	Max. Distance
22 AWG	1500 feet
18 AWG	3900 feet
16 AWG	6200 feet
14 AWG	10,000 feet

Figure 5-1 and Figure 5-2 show how wire length is determined for out-and-back tap and T-tap style wiring.

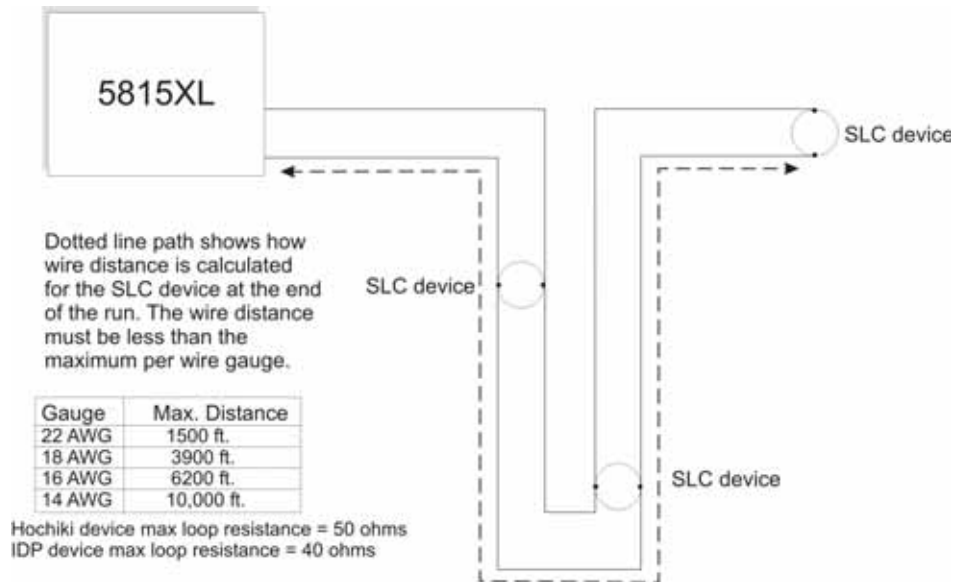

Figure 5-1 Calculating wire run length for a simple out and back tap

When using T-taps, the total length of all taps and the main bus must not exceed 40,000 feet. This requirement must be met in addition to the maximum distance requirements for the various wire gauges.

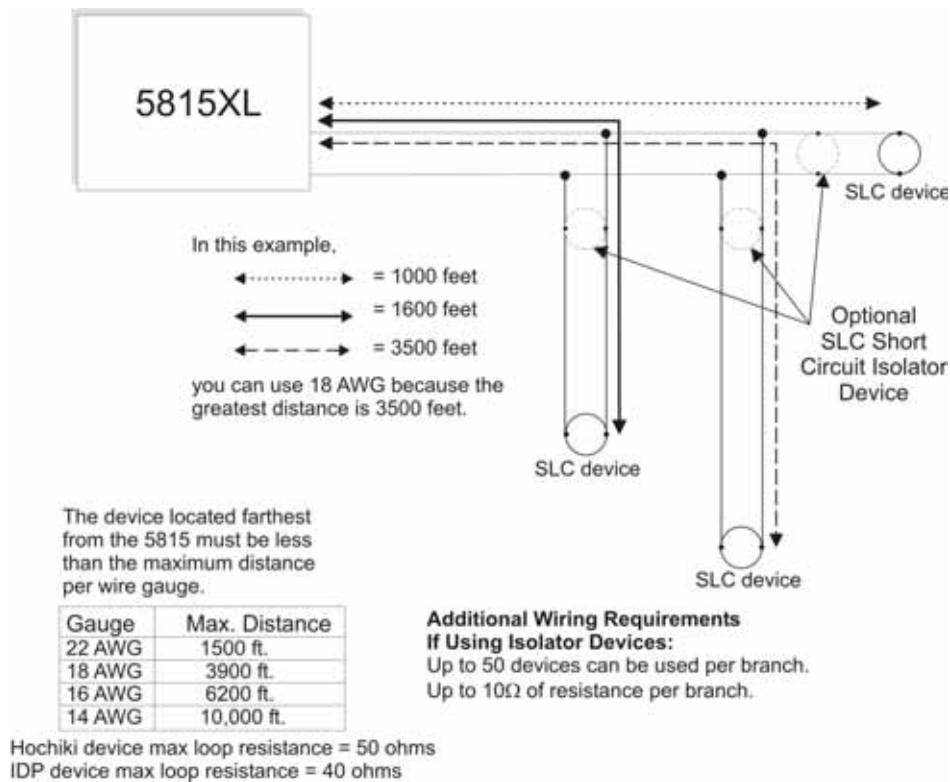

Figure 5-2 Calculating Wire Run Length for a T-tap

5.4.2 Wiring 5815XL in Style 6 & 7 (Class A) Configuration

Figure 5-3 illustrates how to wire the SLC loop for Style 6 or Style 7 Class A installations.

Note: Style 6 does not use short circuit isolator devices.

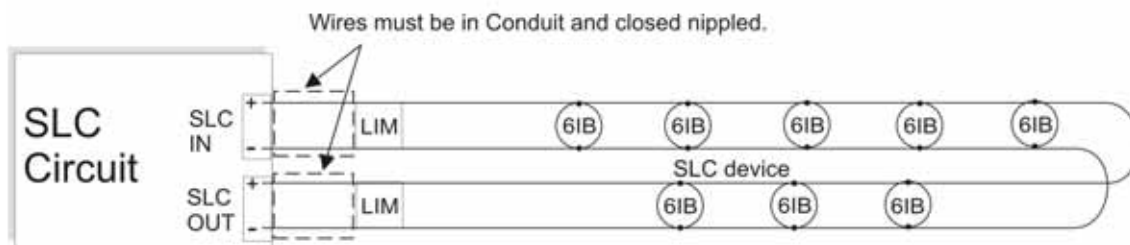
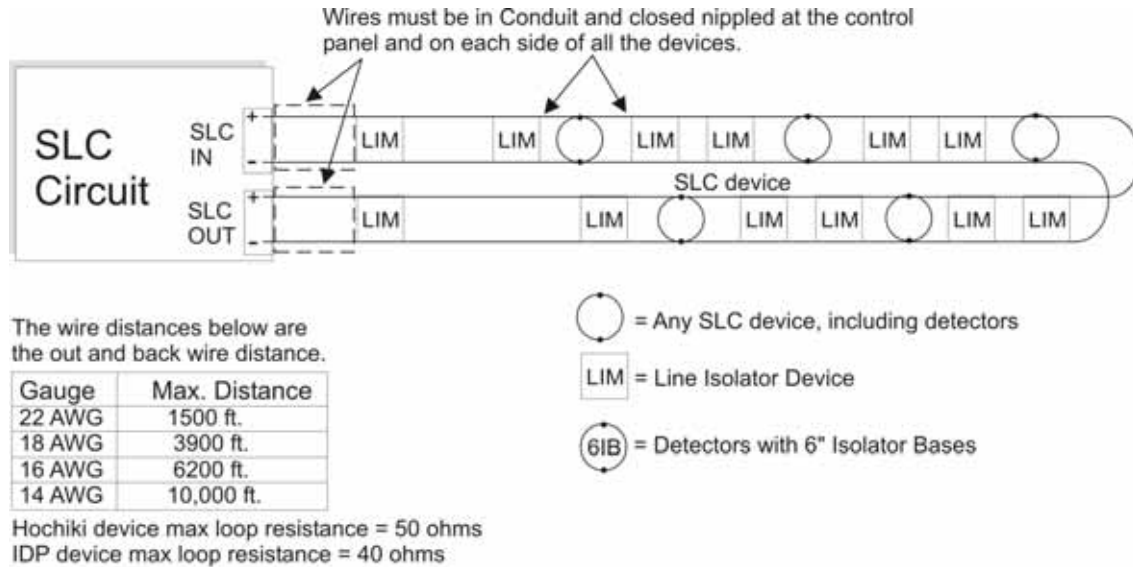

Figure 5-3 Class A SLC Configuration

Note: No t-taps allowed on class A SLC loops.

Caution

For proper system supervision do not use looped wire under terminals marked SLC + and – of the SLC device connectors. Break wire runs to provide supervision of connections.

5.5 Wiring IDP SLC Detectors

This section describes how to install IDP heat and smoke detectors. All detectors ship with installation instructions. Refer to the detector's installation instructions for more detailed information.

This information applies to the following IDP models:

- IDP-Photo Photoelectric Smoke Detector
- IDP-Photo-T Photoelectric Smoke Detector with Thermal
- IDP-Acclimate Photoelectric Smoke Detector with Thermal
- IDP-Heat Fixed Temperature Detector
- IDP-Heat-T High Temperature Thermal Detector
- IDP-Heat-ROR Rate-of-Rise Thermal Detector
- IDP-Ion Ionization Smoke Detector

To wire IDP detectors:

1. Wire device bases as shown in Figure 5-4.
2. Set the address for each device as described in Section 5.6.

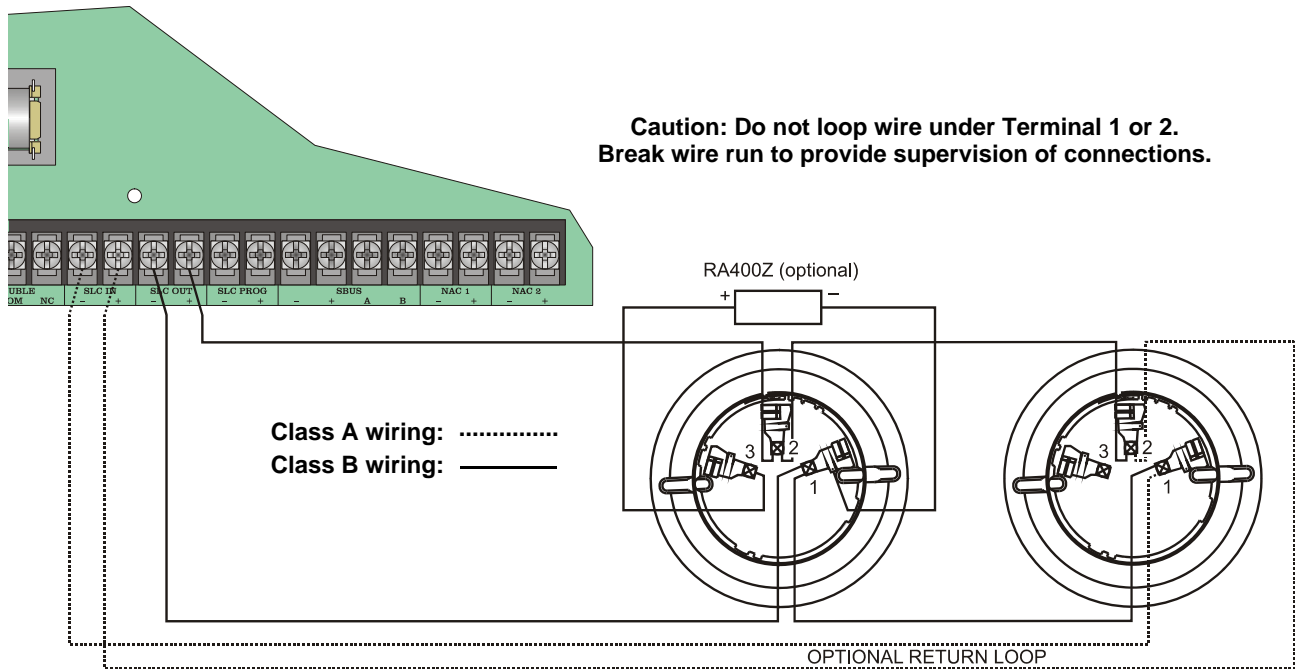

Figure 5-4 Heat and Smoke Detector Connection to the Panel.

5.6 Addressing IDP SLC Devices

All IDP devices are addressed using the two rotary dials that appear on the device board. Use the *ONES* rotary dial to set the ones place in a one or two digit number, and use the *TENS*

rotary dial to set the tens place in a two digit number.

IDP device addresses are handled differently than Hochiki device addresses. The control panel recognizes when an IDP detector or IDP module is installed. For this reason, IDP detectors can be assigned any unique address from 1 to 99, and IDP modules can be assigned any unique address from 1 to 99. Unlike Hochiki detectors and modules which share addresses 1 through 99, there can be an IDP detector using address 1 and an IDP module using address 1. 0 is an invalid address.

Example 1: To select device address 1, turn the *ONES* rotary dial to **1** and the *TENS* rotary dial to **0** as shown in Figure 5-5.

Example 2: To select device address 42, turn the *ONES* rotary dial to **2** and the *TENS* rotary dial to **4** as show in Figure 5-5.

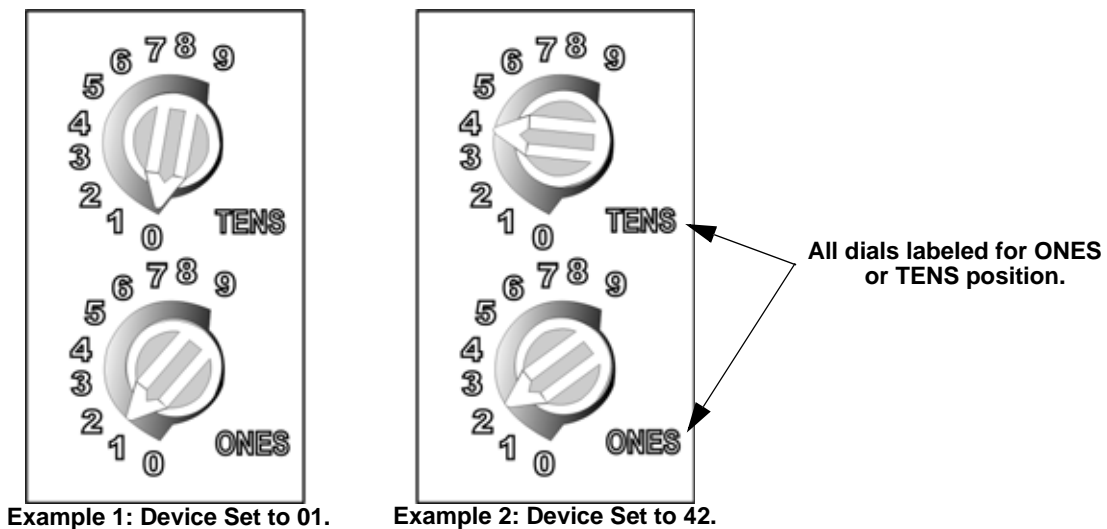

Figure 5-5 IDP SLC Device Addressing Using Rotary Dials

5.7 Wiring Hochiki Detectors

The information in this section applies to the following Hochiki models: SD505-AHS Heat Detector, SD505-AIS Ionization Smoke Detector, and SD505-APS Photoelectric Smoke Detector.

To wire SD505-APS, SD505-AHS, or SD505-AIS detectors:

1. Wire device bases as shown in Figure 5-6.
2. Set the address for each device as described in Section 5.8.

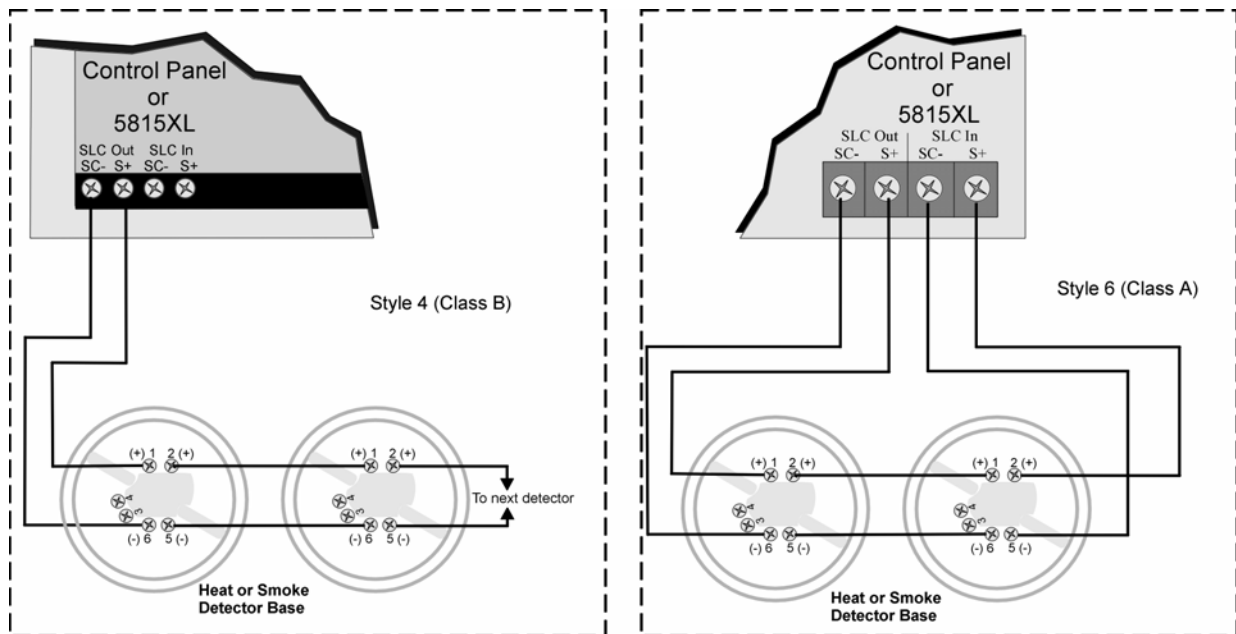

Figure 5-6 Heat or Smoke Detector Connection to the FACP (Class B)

5.8 Addressing Hochiki Devices

This section tells how to address detectors and modules.

5.8.1 SD505-APS, SD505-AHS, & SD505-AIS

The SD505-APS photoelectric smoke detector, SD505-AHS heat detector, and SD505-AIS ionization smoke detector are easily addressed at the FACP. The Installer Code is required to perform this task.

To address a SD505-APS, SD505-AHS, or SD505-AIS:

1. Connect a detector base temporarily to the programming terminals as shown in Figure 5-7. (You can use the same base for each detector.)

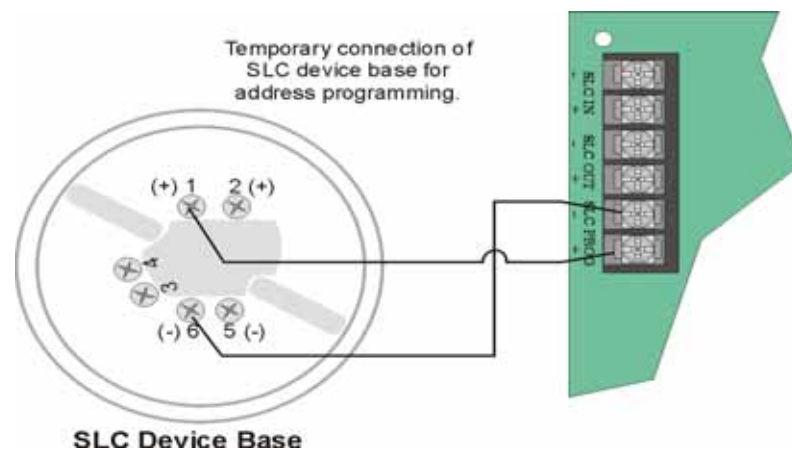



Figure 5-7 Temporary Connection of Detector Base to Panel for Addressing

2. Enter the Installer code, then press **ENTER**.
3. Select **2** for Point Functions.
4. Select **3** for Set SLC Dev Addr.
5. Select “Yes” by pressing the **▲** up arrow, then press **ENTER**. (The panel will go into trouble at this point. You can use the **SILENCE** key to stop the PZT. The trouble will clear automatically when the panel reinitializes when you finish programming.)
6. When the wait message clears, the following options display:
 - 1** for Read Address. Use to read (or check) a single detector’s address.
 - 2** for Write Address. Use to program a single detector’s address.
 - 3** for Seq. Programming. Use to program more than one detector in sequential order.
7. If you are changing addresses, write the programmed address on the back of the device.

8. To exit press  left arrow until fully exited.

5.8.2 Hochiki SLC Devices with Dip Switches

Input and relay module addresses are set using the dip switches on the module board. The chart below shows the available addresses. For example, to select address 3, place dip switches 1 and 2 in the up position. The range of valid addresses is 1-127. 0 is an invalid

address.

ON 

OFF 

Note: Dip switch 8 must always be OFF.

1	2	3	4	5	6	7	8	Address	1	2	3	4	5	6	7	8	Address	1	2	3	4	5	6	7	8	Address	1	2	3	4	5	6	7	8	Address
0	0	0	0	0	0	0	0	0	32	0	0	0	0	0	0	0	0	64	0	0	0	0	0	0	0	0	96								
1	1	0	0	0	0	0	0	0	33	1	0	0	0	0	0	0	0	65	1	0	0	0	0	0	0	0	97								
2	0	1	0	0	0	0	0	0	34	0	1	0	0	0	0	0	0	66	0	1	0	0	0	0	0	0	98								
3	0	0	1	0	0	0	0	0	35	0	0	1	0	0	0	0	0	67	0	0	1	0	0	0	0	0	99								
4	0	0	0	1	0	0	0	0	36	0	0	0	1	0	0	0	0	68	0	0	0	1	0	0	0	0	100								
5	1	0	0	0	0	0	0	0	37	1	0	0	0	0	0	0	0	69	1	0	0	0	0	0	0	0	101								
6	0	1	0	0	0	0	0	0	38	0	1	0	0	0	0	0	0	70	0	1	0	0	0	0	0	0	102								
7	0	0	1	0	0	0	0	0	39	0	0	1	0	0	0	0	0	71	0	0	1	0	0	0	0	0	103								
8	0	0	0	1	0	0	0	0	40	0	0	0	1	0	0	0	0	72	0	0	0	1	0	0	0	0	104								
9	1	0	0	0	0	0	0	0	41	1	0	0	0	0	0	0	0	73	1	0	0	0	0	0	0	0	105								
10	0	1	0	0	0	0	0	0	42	0	1	0	0	0	0	0	0	74	0	1	0	0	0	0	0	0	106								
11	0	0	1	0	0	0	0	0	43	0	0	1	0	0	0	0	0	75	0	0	1	0	0	0	0	0	107								
12	0	0	0	1	0	0	0	0	44	0	0	0	1	0	0	0	0	76	0	0	0	1	0	0	0	0	108								
13	1	0	0	0	0	0	0	0	45	1	0	0	0	0	0	0	0	77	1	0	0	0	0	0	0	0	109								
14	0	1	0	0	0	0	0	0	46	0	1	0	0	0	0	0	0	78	0	1	0	0	0	0	0	0	110								
15	0	0	1	0	0	0	0	0	47	0	0	1	0	0	0	0	0	79	0	0	1	0	0	0	0	0	111								
16	0	0	0	1	0	0	0	0	48	0	0	0	1	0	0	0	0	80	0	0	0	1	0	0	0	0	112								
17	1	0	0	0	0	0	0	0	49	1	0	0	0	0	0	0	0	81	1	0	0	0	0	0	0	0	113								
18	0	1	0	0	0	0	0	0	50	0	1	0	0	0	0	0	0	82	0	1	0	0	0	0	0	0	114								
19	0	0	1	0	0	0	0	0	51	0	0	1	0	0	0	0	0	83	0	0	1	0	0	0	0	0	115								
20	0	0	0	1	0	0	0	0	52	0	0	0	1	0	0	0	0	84	0	0	0	1	0	0	0	0	116								
21	1	0	0	0	0	0	0	0	53	1	0	0	0	0	0	0	0	85	1	0	0	0	0	0	0	0	117								
22	0	1	0	0	0	0	0	0	54	0	1	0	0	0	0	0	0	86	0	1	0	0	0	0	0	0	118								
23	0	0	1	0	0	0	0	0	55	0	0	1	0	0	0	0	0	87	0	0	1	0	0	0	0	0	119								
24	0	0	0	1	0	0	0	0	56	0	0	0	1	0	0	0	0	88	0	0	0	1	0	0	0	0	120								
25	1	0	0	0	0	0	0	0	57	1	0	0	0	0	0	0	0	89	1	0	0	0	0	0	0	0	121								
26	0	1	0	0	0	0	0	0	58	0	1	0	0	0	0	0	0	90	0	1	0	0	0	0	0	0	122								
27	0	0	1	0	0	0	0	0	59	0	0	1	0	0	0	0	0	91	0	0	1	0	0	0	0	0	123								
28	0	0	0	1	0	0	0	0	60	0	0	0	1	0	0	0	0	92	0	0	0	1	0	0	0	0	124								
29	1	0	0	0	0	0	0	0	61	1	0	0	0	0	0	0	0	93	1	0	0	0	0	0	0	0	125								
30	0	1	0	0	0	0	0	0	62	0	1	0	0	0	0	0	0	94	0	1	0	0	0	0	0	0	126								
31	0	0	1	0	0	0	0	0	63	0	0	1	0	0	0	0	0	95	0	0	1	0	0	0	0	0	127								

Figure 5-8 Hochiki SLC Device Addressing Using Dip Switches

Section 6

Programming Overview

This section of the manual is intended to give you an overview of the programming process. Please read this section of the manual carefully, especially if you are programming the control panel for the first time.

The JumpStart feature automates many programming tasks and selects default options for the system. You will run JumpStart at least once when you are installing the system. See Section 6.1 for details. After you run JumpStart, you may need to do some additional programming depending on your installation. Section 7 of this manual covers manual programmable options in detail.

Programming the panel can be thought of as a three part process. You must program:

- System options. These are options that affect general operation of the panel (see Section 7.7 for details).
- Options for input points and zones. These are primarily options that control detection behavior of devices (see Section 7.6 for details).
- Options for output points and groups. This includes selecting characteristics for output groups and mapping output circuits to output groups (see Section 7.6 for details).

6.1 JumpStart Autoprogramming

The JumpStart feature allows for faster system setup. When you run JumpStart (immediately after addressing SLC devices), the system scans devices on all SLC loops and determines device type (for example, ionization smoke detector or heat sensor) and selects some system options based on the device type. This saves the installer from having to program options for each device. Depending on the application, the installer may need to make some changes after JumpStart completes.

See Section 6.1.3 for complete details about running JumpStart.

IMPORTANT

JumpStart is intended to be run one time only, immediately after SLC devices have been addressed and connected. JumpStart will reset all manually programmed options to default settings. Do not run JumpStart after you have configured the system.

6.1.1 Input Points

JumpStart will determine the number and type of input points (detectors or contact monitor modules) on each SLC loop. JumpStart assigns the correct detector type (heat, ionization or photoelectric), so the installer does not need to edit device type for detectors. Any contact monitor modules on the system will be assigned type "Manual Pull." The installer will need to manually change the switch type if manual pull is not correct.

JumpStart creates one zone (Zone 1) and assigns all input points to Zone 1. Zone 1 is mapped to Output Group 1. If the system has a VIP-50, then Output Group 2 will also be created and all input points will be mapped to both Group 1 and Group 2. After JumpStart completes, you can re-map to configure a multiple zone/output group system (see Section 7.4.1.3). For a general explanation of mapping, see Section 6.2.

6.1.2 Output Points

JumpStart creates three output groups and assigns output circuits as follows:

Circuits 1-4:

Configured as Notification and assigned to Group 1. JumpStart automatically programs Zone 1 to activate Group 1 using constant on output.

Circuit 5 (Relay 1):

Assigned to Group 124. JumpStart automatically programs Zone 1 to activate Group 124 using constant on output when a supervisory condition occurs.

Circuit 6 (Relay 2):

Assigned to Group 125. JumpStart automatically programs Zone 1 to activate Group 125 using constant on output when an alarm occurs.

Addressable output points (Relay modules, NAC Modules, Sounder Bases, Relay Bases):

All addressable relay devices will be configured as "Output Pt" (general purpose output point) and assigned to Group 1.



Note: Relay output is constant even if the zone activating the relay is programmed with an output pattern.



6.1.3 Running JumpStart



















Run JumpStart immediately after you have addressed and connected all input devices (detectors, pull stations, and so on) and output devices (notification appliances, relays, and so on).

Note: If you need to install a few devices after you have run JumpStart, you can install them manually. Follow instructions in Section 7 for configuration.

To run JumpStart, follow these steps.

1. Press  to view the Main Menu.
2. From the Main Menu Select  for the Program Menu.
3. From the next menu, select  for JumpStart.

4. The message "WARNING Will DELETE all system options" displays on the LCD. Select Yes to continue. A series of messages displays for the next several seconds. JumpStart scans the SLC loops for devices. This can take several minutes, depending on the number of devices attached.
5. When the message, "SLC FAMILY HOCHIKI" flashes. Press  to accept Hochiki if installing, or press  to display IDP and press  to accept IDP.
6. When the message "Configuring System Done" displays, press any key to continue.
7. Select one of the following options from the menu that displays.

<p> - Review System</p>	<p>Press  if you need to review the JumpStart configuration.</p>
<p> - Repeat JumpStart</p>	<p>Press  if you need to rerun JumpStart for any reason.</p>
<p> - Accept Configuration</p>	<ol style="list-style-type: none"> 1. If you are ready to make the JumpStart configuration permanent, select . 2. The system will ask you if the installation contains duct detectors. If there are none, select  for No and skip to Step 8. If the system contains duct detectors, select  for Yes and continue with Step 3. 3. From the list that displays, select the SLC device that contains the duct detectors. 4. The first photoelectric or ionization detector on the system will display. Select  for DUCT and  for NonDUCT. 5. Press  to select the next detector. Select  for DUCT and  for Non-DUCT. Continue until all duct detectors have been selected. (Note: You can move backwards through the list with .) 6. When you reach the last detector on this device, press . 7. The system will ask you if there are more duct detectors in the system. If there are, select  for Yes and repeat from Step 3. If there are no more duct detectors, select  for No and continue with Step 8. 8. The system will restart in 10 seconds. You can press  to restart immediately. Do not select  for System Diagnostics. (This feature is for use in testing at the factory.) 9. After the system resets, it will use the new JumpStart configuration.

6.2 Mapping Overview

This section of the manual is an overview of mapping. Details about how to select mapping options appear in the appropriate subsections in Section 7.

Mapping is an important concept with the control panel. In general terms, mapping is assigning or linking events to outputs that should activate when events occur. You do this by assigning input points to input zones, output points to output groups and then linking or mapping zones and output groups.

Figure 6-1 is a brief overview of the concept of mapping. The next several pages of the manual show these subjects in detail.

In its simplest application, mapping is determining which outputs are activated by which inputs.

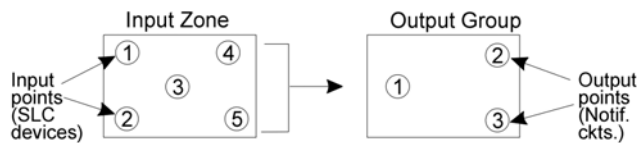

Because the Control Panel programming is so flexible, there are a number of uses for mapping, as shown in the diagram below.

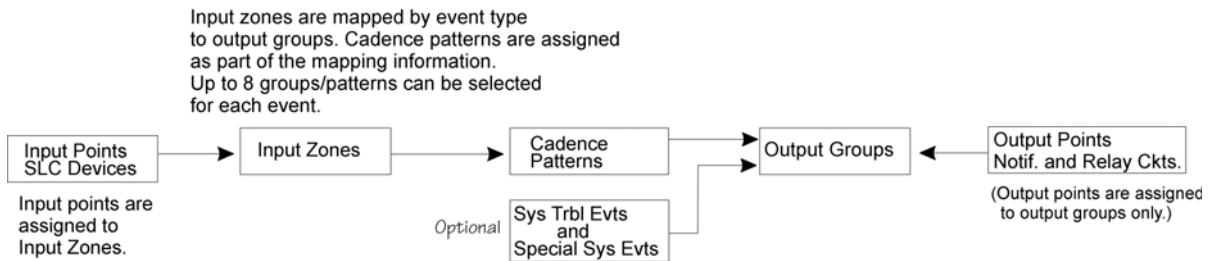

Figure 6-1 Mapping Overview

6.2.1 Input Point Mapping

Input points are assigned to input zones. Any input point can be assigned to any input zone. (Input points can be assigned to one zone only. An input point can be designated as "Unused," which means it has not been assigned to a zone.)

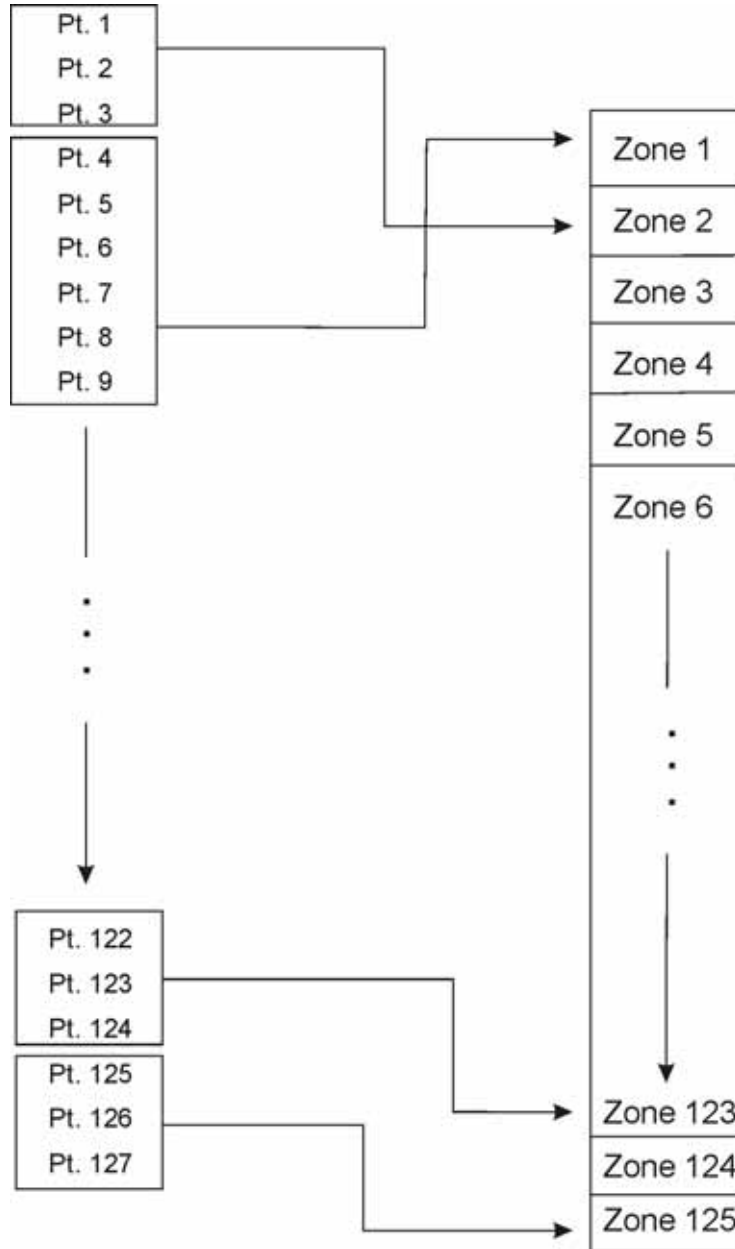

Figure 6-2 Input Point Assignment Example

6.2.2 Output Circuit Mapping

Figure 6-3 is a simple example showing how to assign notification and relay output circuits to groups. For an example of a simple floor above/floor below application, see Figure 6-5.

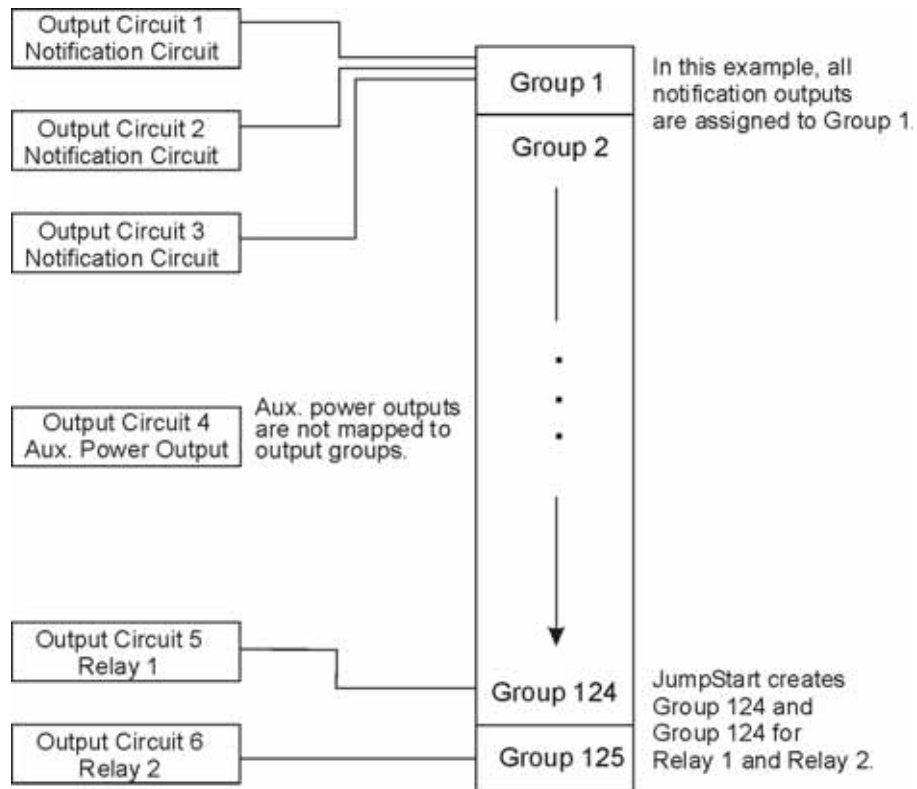

Figure 6-3 Assigning Output Circuits to Groups (Example)

6.2.3 Zone Event Mapping

There are 8 types of events that can occur in zones (see below). For each event type, you can activate up to 8 output groups and patterns. If it is necessary to map to more than 8 output groups, an output group template may be used (see Section 7.5.5 for information on output group templates). Event types are:

- Manual Pull Alarm
- Water Flow Alarm
- Detector Alarm (heat or smoke detectors)
- Aux 1 and Aux 2 Alarm (user-specified alarm types)
- Pre-alarm
- Supervisory
- Trouble

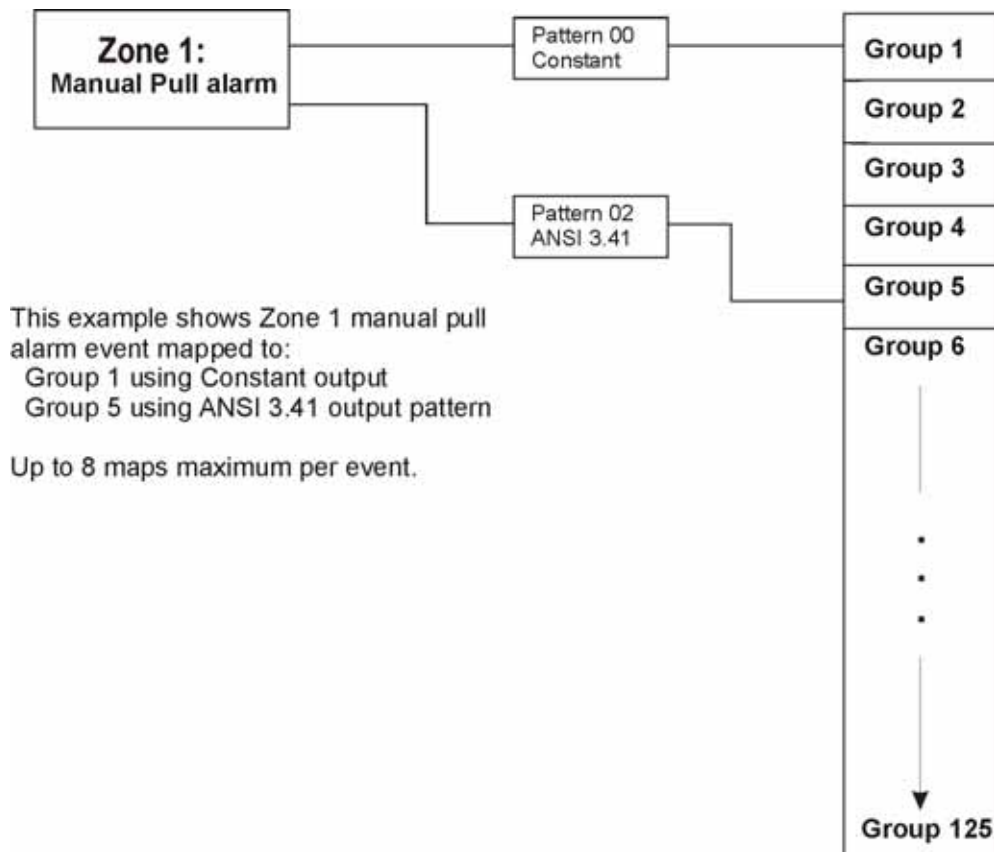

Figure 6-4 Example of Zone Events Mapped to Output Groups and Patterns

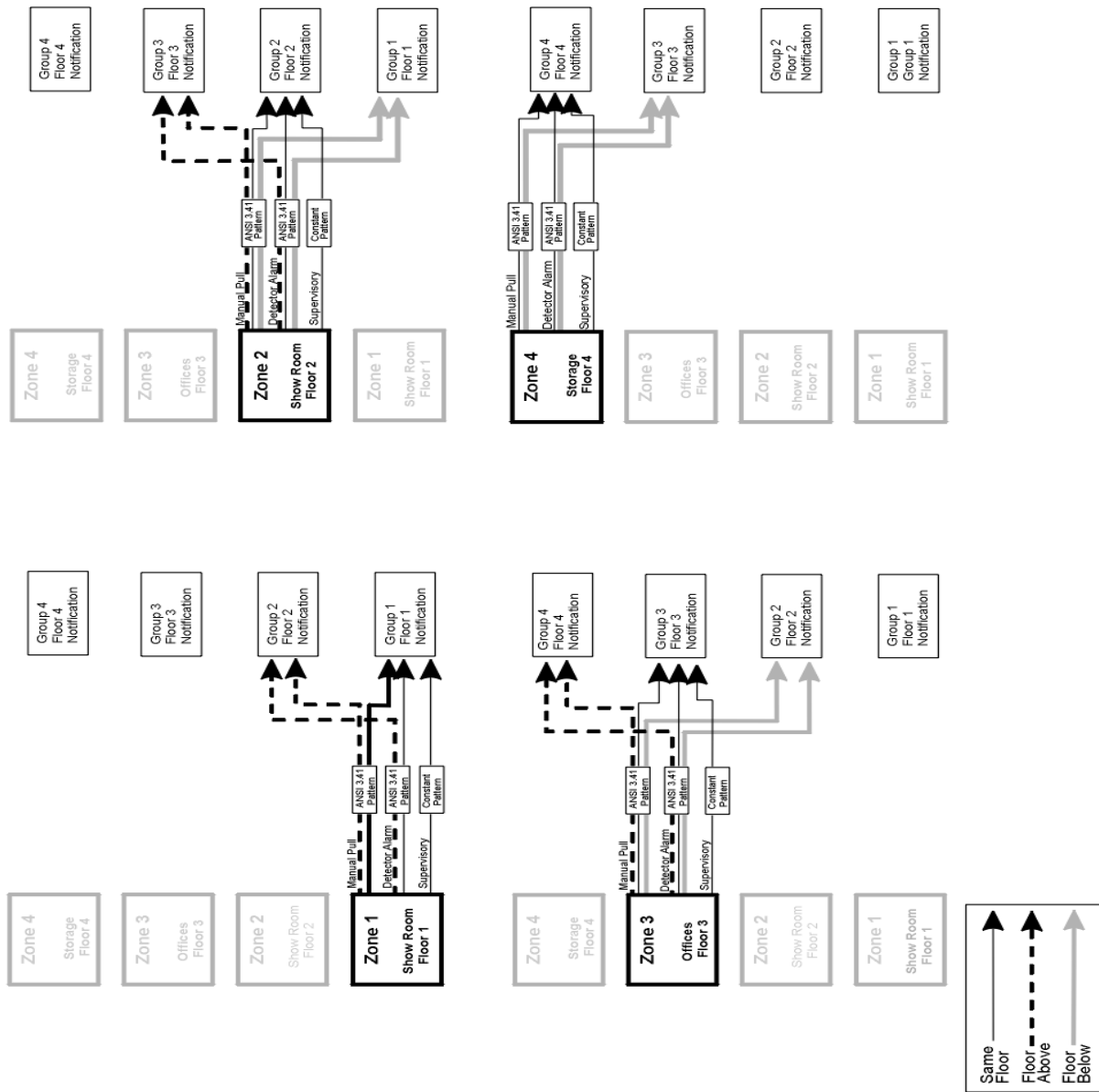

Figure 6-5 Example of Zone Events Mapped to Output Groups and Patterns

6.2.4 Mapping LED Points

Figure 6-6 is a simple example showing how LED points are mapped to zones and output groups. Typically you would create two output groups for each zone, one for alarms and one for troubles. (LED points are available when Models 5865-3/4 and/or 5880 are used with the system.)

Mapping LEDs to Zones and Output Groups

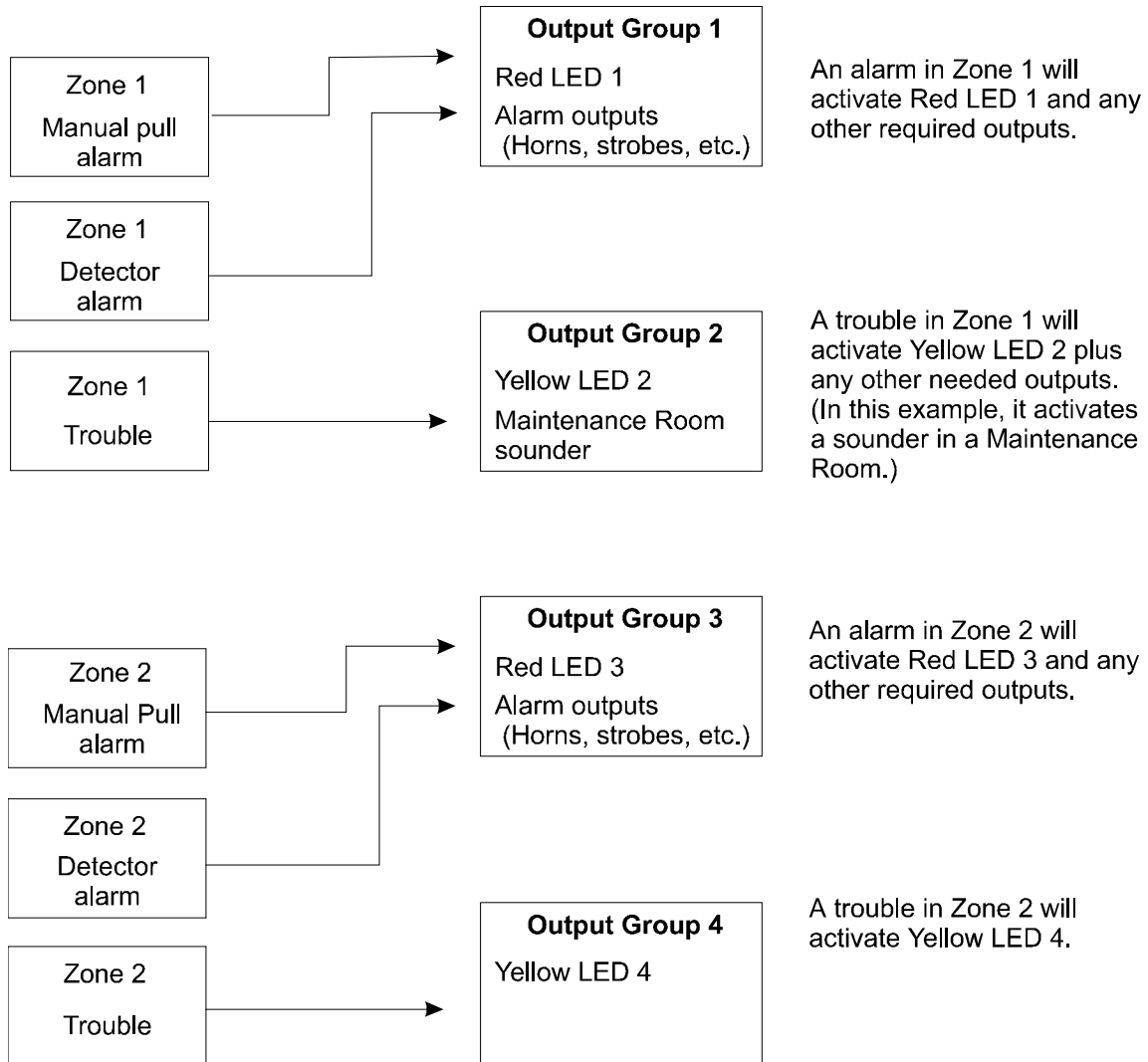

Figure 6-6 Example of LED Points Mapped to Output Groups (applies to Models 5865-3/4 and 5880)

6.3 Programming Using the 5650/5651 Silent Knight Software Suite

You can use the 5650/5651 Silent Knight Software Suite (SKSS) to program the control panel onsite or remotely. SKSS is an optional software package that lets you easily program the control panel using a Windows-based computer and a modem* (not sold by Silent Knight). When using SKSS, you can set up the programming options for the panel, save the options in a file, then download the file to the panel. You connect to the control panel directly using the control panel's onboard USB or serial port or remotely using a modem. If you need to connect to an older control panel that does not have a USB port, and your laptop does not have a serial port, use a USB to serial converter. SKSS includes an online help system and a manual. See the SKSS manual (PN 151239) for more information.

* See Section 1.3 for a list of modems that have been tested for compatibility with the control panel and SKSS.



6.4 Programming Using an Annunciator

You can program the control panel from a system annunciator, using either the control panel's on-board annunciator or a RA-100 Remote Annunciator.

The following subsections describe programming basics, including a description of editing keys available for programming and how to move through programming menus. Section 7 contains specific information about individual programming options.

6.4.1 Entering / Exiting the Programming Menu

To enter the Programming Menu:

1. Press the  or  key to bring up the Main Menu (see Figure 6-7).
2. Enter the Installer Code (factory programmed default code is 123456) if prompted.

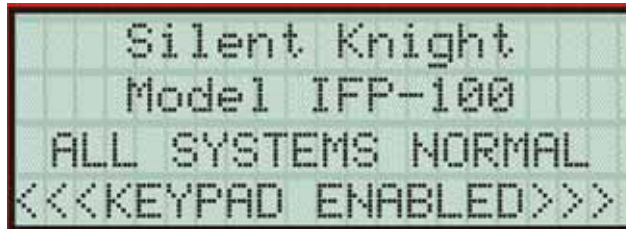



Figure 6-7 Keypad Enabled Screen

3. press . The menus described in Section 7 of this manual will display. Section 6.5 of this manual is a quick reference listing all programmable options and JumpStart defaults.

To exit the programming menu:

When you have completed working with the menus, press  (left arrow) several times until you are exited from programming mode. Two prompts will display. The first prompt is to make sure you intended to leave the Program Menu (select Yes or No as appropriate). The second prompt is for accepting all changes. If you select No, any changes you have made since you entered the Program Menu will have no effect.

6.4.2 Moving through the Menu

Figure 6-8 shows how to move through Program Menu screens, using the System Options screen as an example.

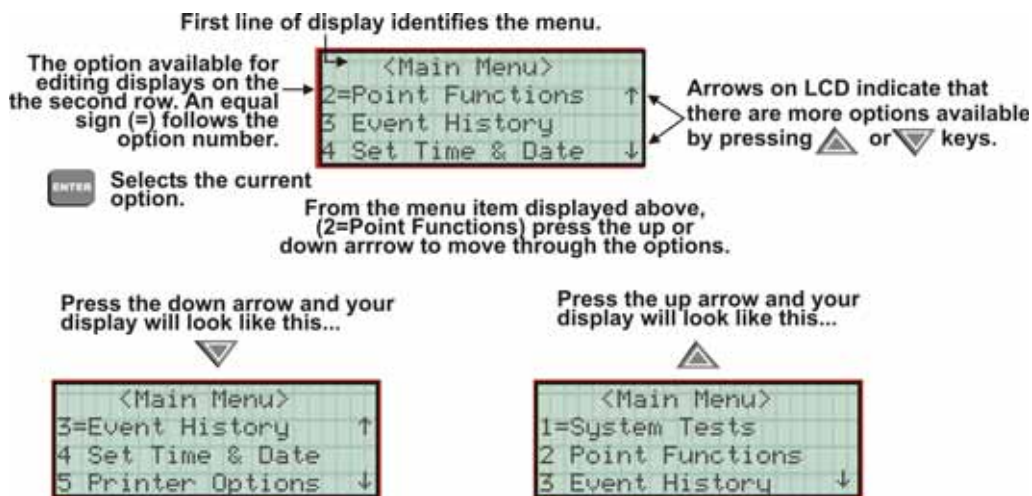





Figure 6-8 Moving through Program Menu (System Options Sub-Menu Used as an Example)

6.4.3 Selecting Options and Entering Data

There are several ways to make programming selections using the control panel depending on which screen you are currently using. The chart below is a generic explanation.

Table 6-1

To	Press
Select from a menu.	Enter the number of the option.
Enter numeric data.	Press the appropriate number on the annunciator.
Enter text (alphanumeric data).	Enter each letter individually by pressing and holding any numeric key until the one you wish to select displays. Then press  (right arrow) to select the letter.
Select from a scrolling list.	Use  (up arrow) and  (down arrow) to move through a list of available options. When the option you want to select is displayed, press  .

6.4.4 Editing Keys

The keys shown in Figure 6-9 are available for use when you are in the Program Menu.

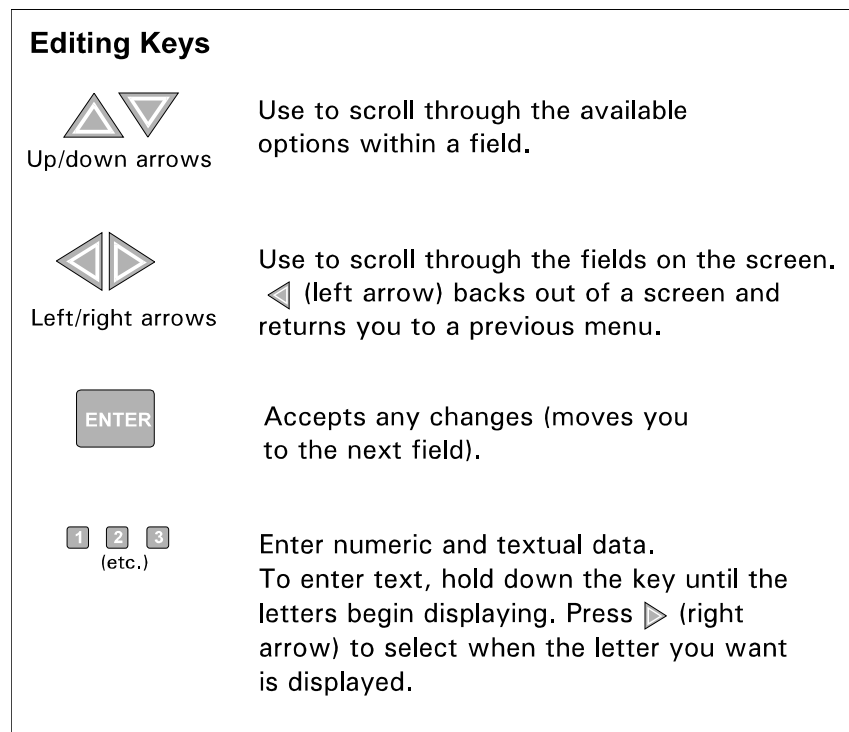

Figure 6-9 Editing Keys Available from Program Menu

6.5 Programming Menu Quick Reference

This section of the manual lists all Program Menu options in the order they appear on the sub-menus. Default settings are indicated in text or marked with an asterisk. The comments column provide quick information and a reference to a section (if applicable) which has more detailed information.

Menu	Options/Defaults					Comments	
SLC Family	Hochiki					Section 7.2	
	IDP						
Module	Edit Module	Select Module	Enter Module Name	Select Class		Section 7.3.1	
	Add Module	RA-100-Keystation				Section 7.3.2	
		RA-1000-Keystat.					
		5824-Ser/Par/IO					
		5496 NAC Expand					
		RPS-1000 Pwr Sup					
		5880-LED/IO Dev					
		5865-LED Annunc					
		VIP-50					
	VIP-VCM				Section 7.3.2		
VIP-RM							
Delete Module	List of Modules				Section 7.3.3		
View Module List	List of Modules						
Zone	Edit Zone	Select Zone to Edit	Edit Zone Name	Enter Name 1		Section 7.4.1	
				Enter Number 1			
				Enter Name 2			
				Enter Number 2			
			Zone Properties	Verification Type	*1 Count		
					2 Count		
					Alarm Ver.		
					PAS		
					SNGL ILOCK		
					DBL ILOCK		
			Heat Temp Set	135° to 150°F	Hochiki devices		
				135° to 190°F	IDP devices		
			Smoke Sens.	Low, Med, or High			
Zone Outputs	Manual Pull (MP)	(Groups 01 & 250, Pattern 00)	Section 7.4.1				
	Water Flow (WF)						
	Detector Alarm (DE)						
	Aux 1 (A1)	no group					
	Aux 2 (A2)						
Pre-alarm (PR)							

Menu	Options/Defaults				Comments	
Zone (cont.)	Edit Zone (cont.)	Select Zone to Edit (cont.)	Zone Outputs (cont.)	Supervisory (SU)	(Group 249, Pattern 00)	Section 7.4.1
				Trouble (TR)	no group	
			Zone Accessry Opt	Cadence	00-20	
				Local Zone	Yes or No	
	Add Zone	Adds next available zone number.				Section 7.4.2
Delete Zone	Select Zone to be Deleted				Section 7.4.3	
View Zone Points	List of all points in selected zone.				Section 7.4.4	
Group ¹	Edit Group	Select Group	Group Name	Enter Name1		Section 7.5.1.1
				Enter Number1		
				Enter Name2		
				Enter Number2		
			Group Properties	Latching Options	*Non- Latching	
					Latching	
				Silencing Options	*SILENCE	Silenceable
					NON-SIL	Non-Silenceable Section 7.5.1
					Auto Unsilence	Auto Un-silenced Section 7.5.1
					SIL-INHIB	Silence after inhib delay. Section 7.5.1
					SHUT- DOWN	Automatic Shutdown Section 7.5.1
				VIP Switch No.	1 through 32	Section 7.5.1
				Group Active With:	Group Activates for all Man. Pull	*No
					Group Activates for Fire Drill	*Yes
			Group Activates for Aux 1		*No	
			Group Activates for Aux 2		*No	
			Ignore Global Cadence		*No	
Add Group					Section 7.5.2	
Delete Group	Select Group to Delete				Section 7.5.3	
View Group Points	Select Group				Section 7.5.4	
Edit OPG Template	Select Template Number	Select Group			Section 7.5.5	
		Include in template	Yes			
			No			
Select Pattern	0-20	0 = Constant. Refer to Figure 7-5				

Menu	Options/Defaults			Comments		
Point	Hochiki SLC Loop	Enter Pt	UNUSED			
			DETECTOR	PHOTO	Select zone	Section 7.6
				ION		
				HEAT		
				PHOT DUCT		
				ION DUCT		
				2WIRE SMK		
			SUP DET	SUP PHOTO	LATCH	
					NLATCH	
				SUP ION	LATCH	
					NLATCH	
			SWITCH	MAN_PULL		
				WATERFLOW	LATCH	
					NLATCH	
				SUPERVSY	LATCH	
					NLATCH	
				FIREDRILL		
				SILENCE		
				RESET		
				PAS_ACK		
				ZN_AUX1	LATCH	
					NLATCH	
				ZN_AUX2	LATCH	
					NLATCH	
				RELAY	OUTPUT PT	
			AUX RESET			
			AUX DOOR			
			SLC LED	LED No. 01-80	Select Group	

Menu	Options/Defaults			Comments		
Point (cont.)	IDP SLC Loop	Enter Pt	UNUSED		Section 7.6.1.	
			DETECTOR	PHOTO		Select Zone
				ION		
				HEAT		
				PHOT DUCT		
				2WIRE SMK		
				Acclimate		
				Heat HT		
				Photo-Heat		
				Beam		
		SUP DET	SUP PHOTO			
		Enter Pt (cont.)	SWITCH	MAN_PULL		
				WATERFLOW	LATCH	
					NLATCH	
				SUPERVSY	LATCH	
					NLATCH	
				FIREDRILL		
				SILENCE		
				RESET		
				PAS_ACK		
				ZN_AUX1	LATCH	
					NLATCH	
				ZN_AUX2	LATCH	
					NLATCH	
				SYS_AUX1	LATCH	
					NLATCH	
				SYS_AUX2	LATCH	
					NLATCH	
DETECT SW						
TAMPER	LATCH					
	NLATCH					
MAN REL						
ILOCK						
NOTIF	OUTPUT PT	Select Group				
	AUX CONST					
	AUX RESET					
	AUX DOOR					
RELAY	OUTPUT PT	Select Group				
	AUX RESET					
	AUX DOOR					

Menu	Options/Defaults				Comments	
Point (cont.)	Internal Pwr and External Power	Select Type	UNUSED		Section 7.6.2	
			B NOTIF	Select Group		
			A NOTIF			
			AUX PWR	CONSTANT		
				RESETABLE		
	DOOR					
		Select Group or Zone Number			Group or Zone selection will appear depending on the type is selected. Section 7.6.2	
		Edit Name	Enter Name		Section 7.6.2	
	5880	Enter Point #	NOTIF		Section 7.6.3	
			UNUSED			
		Select Group #				
		Edit Name	Enter Name			
	5865	Enter Point #	NOTIF		Section 7.6.3	
			UNUSED			
		Select Group #				
	Edit Name	Enter Name				
VIP-50	Enter Point #	NOTIF		Section 7.6.3		
		UNUSED				
	Select Group #					
	Edit Name	Enter Name				
System Options	Reporting Accounts	Edit Acct.	For each account (1-4), select:			
			Edit Account #		*123456	Account # (6-digit number, identifies account to central station) Sec. 7.7.1.1
			Edit Format		*Contact ID	Reporting Format (SIA, S20, Contact ID) Sec. 7.7.1.1
			Report Alarms	Y (Yes)	*Yes	Section 7.7.1.1
				N (No)		
				M (Must)		
			Rep. Alarm Restore	Y (Yes)	*No	
				N (No)		
				M (Must)		
			Report Troubles, Supervisories, Enable/Disable	Y (Yes)		
				N (No)		
				M (Must)		
Report Test	Y (Yes)					
	N (No)					
	M (Must)					
Report Resets	Y (Yes)					
	N (No)					
	M (Must)					

Menu	Options/Defaults				Comments		
System Options (cont.)	Reporting Accounts (cont.)	Edit Acct. (cont.)	Switch attempts	1 - 5	*5	Section 7.7.1.1	
			Edit Phone #1	up to 24 digits	blank	Section 7.7.1.1	
		Auto Test Time	Set the Hour			*02:00 AM	Section 7.7.1.2
			Set the Minutes				
	Select AM/PM						
	Phone Lines	Select Phone Line	For each phone line (1 & 2), select:				
			Dialing Prefix	Up to 8 digits	none	Section 7.7.2.1	
			# of Answer Rings	Range: 00-15	06	Number of rings before panel answers a call from a computer Section 7.7.2.2	
			Select Dialing Option	TT	TouchTone	TouchTone alternating with pulse. Section 7.7.2.3	
				TT/PL			
				PULSE			Pulse dialing
			Rotary Pulse Format	U = 60/40 E = 66/34	*U	Section 7.7.2.4	
			Line Monitor	Yes	*Yes	Section 7.7.2.5	
				No			
			Enable Ground Start	Yes = enabled	*N = Disabled	Section 7.7.2.6	
				No = disabled			
			Answering Machine Bypass	Yes = enabled	*Y = Enabled	Section 7.7.2.7	
				No = disabled			
	System Event Outputs	Trouble Events	System Trouble	Select Group	None selected	Section 7.7.3.1	
				Select Cadence			
				Alarm Silence			Select Group
			Select Cadence				
			Trbl Silence	Select Group	None selected		
				Select Cadence			
			User Selected	Group Tr	Select Group		
				SBUS Com			
				SBUS Pwr			
SLC Loop							
AC Loss							
Battery							
User Selected			Gnd Flt	Select Cadence			
			Phone Ln				
			Account				
	Printer						
	Aux Pwr						
	Sys Sw						
Sys Alarm Cadence	Fire Drill	Select Cadence	Constant	Section 7.7.3.2			
	System Aux1						
	System Aux2						

Menu	Options/Defaults				Comments		
System Options (cont.)	Day/Night Sense.	Enable/Disable	Yes		*N = Disabled	Section 7.7.4	
			No				
		Day Start	enter time				
		Night Start	enter time				
	Days of the Week	Select days					
	Holidays	Holidays 1 to 9	Enter dates			Section 7.7.5	
	Misc. Options 1	Water Flow Delay	0 - 90 Seconds	*30 sec	Water Flow delay is the number of sec before water flow alarm is generated. Section 7.7.6.1		
		Low AC Delay	0 - 30 hours	*3 hrs		Low AC Report Delay. Sec. 7.7.6.2	
		DST	Y (Enabled)	*Enabled	Automatic Daylight Saving Time enable or disable. Section 7.7.6.3 and 7.7.8.2. See also DST settings in Misc. Option 3, below.		
			N (Disabled)				
		CLK	AM/PM	*AM/PM	System Clock Format (AM/PM or military). Section 7.7.6.4		
	MIL						
	AC Freq:	50 Hz				Section 7.7.6.5	
		60 Hz					
		Neither					
	Misc. Options 2	SYNC Strbs w/ Sil	Y (Enabled)	*Disabled			Section 7.7.7.1
			N (Disabled)				
		Auto Display Oldest	Y (Enabled)	*Disabled			Section 7.7.7.2
	N (Disabled)						
	Report By	Zone	*Zone			Section 7.7.7.3	
		Point					
	Misc. Options 3	Alarm Verification time	Enter time from 1 to 250 seconds	*60 Seconds		Section 7.7.8.1	
		DST Start	Select week: 1st, 2nd, 3rd, 4th or Last	Select month	Section 7.7.6.3 and 7.7.8.2. See also DST settings in Misc. Options 1, above.		
		DST End					
	Edit Banner	Internal Message				Section 7.7.9	
		Custom Message	Edit Line 1				
			Edit Line 2				
	Edit Voice Cmds	Select Command 1-6	User Message	Tone Select	*User Message	Section 7.7.10	
Tone only							
Message 1							
Message 2							
Repeats			1-14				
			Continuous				
			None				
Initial Delay			0 - 28 (4 sec. increments)	*12			
Inter message Delay			4 - 32 (4 sec. increments)	*8			
Allow Message Restart with new alarm	Yes (Y) NO (N)	* No					

Menu	Options/Defaults					Comments
JumpStart AutoPrg	No					Section 7.8
	Yes					
Computer Account	Computer Account #	*123456				Section 7.9
	Computer Access Code	*0				
	Computer Phone #	Up to 24 digits				
Access Codes	Select Profile (01 - 20)	Edit Panel Functions	Edit Name			<p>Profile 1 is the profile that dictates what functions the Fire Fighter Key has access to. Because this is the profile for a key the user name and the access code can not be edited for this profile.</p> <p>Profile 2 is the profile for the installer and is referred to as the "Installer Code". This profiles user name and panel functions can not be edited.</p> <p>Section 7.10.</p>
			Edit Access Code			
			System Reset			
			System Silence			
			System Event Ack.			
			Fire Drill Key			
			System Tests			
			Fire Drill Menu			
			Indicator Test			
			Walk Test no-Report			
			Walk Test w/Report			
			Dialer Test			
			Clear History Buffer			
			Point Functions			
			Disable/Enable Point			
			Point Status			
			Set SLC Device Address			
			SLC Device Locator			
			SLC Multi-Device Locator			
			I/O Point Control			
			Event History			
			Set Time & Date			
			Printer Options			
			Event Logging			
			Print Event History			
Print Detector Status						
Print System Config						
Reset Dialer						
Program Menu						
System Information						
Upload/Download						
VIP-VCM Maint.	PC Connection					Section 7.11
	Local Recording	Select Module	Select Circuit	Select VCM Switch		

1. Use of multiple notification groups may not synchronize with each other.

Section 7

Programming

This section of the manual describes how to manually program the control panel from the built-in annunciator. Each subsection discusses these menu options in detail. All options described in this section can be performed using the Silent Knight Software Suite 5650/5651.

Important!

Before any customized programming is done, Jump-start should be run first. After Jump-start is run, thoroughly test the system. The reason the system should be tested after Jump-start is because Jump-start automatically programs the system, searching for and configuring all SLC and SBUS devices it finds. Jump-start allows you to confirm the integrity of the installation prior to performing any custom programming. After determining that the hardware is properly installed, custom programming can be performed. Refer to Section 6.

7.1 UL 864 Programming Requirements

NOTICE TO USERS, INSTALLERS, AUTHORITIES HAVING JURISDICTION, AND OTHER INVOLVED PARTIES: This product incorporates field programmable software. In order for the product to comply with the requirements in the Standard for Control Units and Accessories for Fire Alarm Systems, UL 864, certain programming features or options must be limited to specific values or not used at all as indicated below.

Programming Option	Menu Item	Permitted in UL 864 (Y/N)	Possible Settings	Settings Permitted in UL 864
Phone Lines	Enable Gnd Start	No	Yes & No	No
Misc Options 1	Low AC Report Delay	Yes	0–30 hours	1–3

5. Press **[I]** to edit a module.
6. Use the **▲** or **▼** arrow to select the module you wish to edit.

7.3.1.1 Naming Modules

You can assign an English name to a system hardware module to make it easier to recognize on a display.

7. If you wish to edit the modules name press the **▲** or **▼** arrow to select each character for the modules name (or press **▶** to bypass name edit).

Press the **▶** to move to the next character.

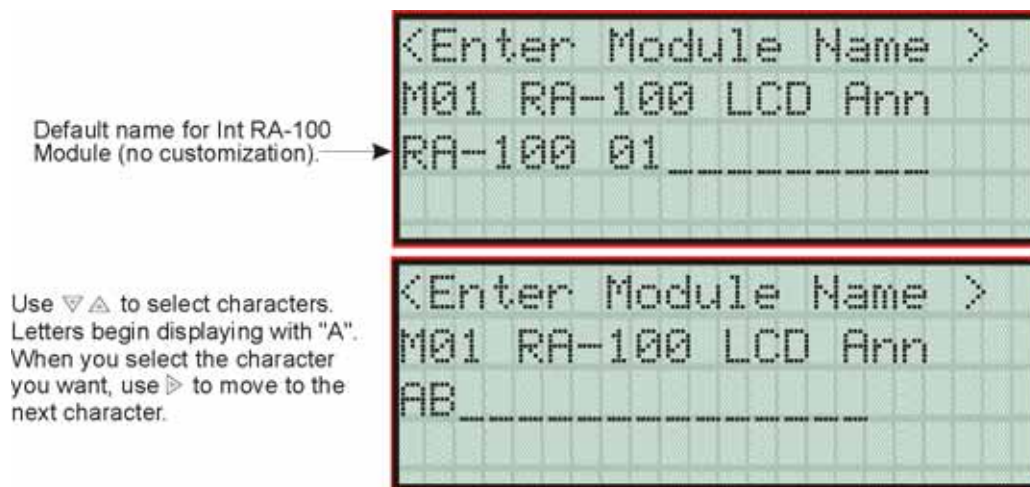

Figure 7-1 Edit module Name Programming Screen Example

7.3.1.2 Module, Wiring Class

This option applies only to the SLC loop. Each module has a unique set of option that specifically applies to the functionality of the module being edited.

8. Choose the class of wiring you wish to use for this module by pressing the **▲** or **▼** arrow, then press **ENTER**.

7.3.2 Adding a Module

If you need to add a new hardware module to the system, follow these steps.

You must be in the Main Menu to perform this task. If necessary, enter the Installer Code.

1. Press **▶** or **ENTER** to display the main menu.
2. Select **[7]** for Program Menu.
3. Enter code if prompted.

Display reads: Initializing

```
Please wait . . .
```

4. Press **1** to enter module menu.
5. Press **2** to add a module.
6. From the next screen, select the number that corresponds to the type of module you are adding from the <New Module Type> screen.

The screen will display “Adding module [#]...” for a few moments. You will be returned to the <New Module Type> screen where you can select another module if desired.

You must save changes when you exit the Program Menu or the new module will not be added.

Note: If you Add a Module that has not been physically connected, the panel will go into trouble after it reinitializes (when you exit the Program Menu). When the new module is attached, the trouble will correct itself automatically the next time you power up the system.

7.3.3 Deleting a Module

If you ever need to delete a module, follow these steps.

You must be in the Main Menu to perform this task. If necessary, enter the Installer Code.

1. Press **▶** or **ENTER** to display the main menu.
2. Select **7** for Program Menu.
3. Enter code if prompted.

```
Display reads:      Initializing
                   Please wait . . .
```

4. Press **1** to enter module menu.
5. Press **3** to delete a module.
6. A warning screen will display. If you want to proceed with deleting the module, select Yes. To cancel, select No.

7.4 Zone

Through the zone option in the program menu you can edit, add, delete, and view zone points. Selections made here affect all detectors and switches in the zone. Up to 125 zones can be used in the system.

7.4.1 Edit Zone

Features that can be edited through the edit zone option are, edit zone name, zone properties (which includes, zone type, and detector sensitivity), and zone output mapping.

To edit a zone, follow these steps:

8. Select the characters for the zone name by pressing the ▲ or ▼ arrow until the desired character is shown then press ▶.

OR

Enter the Numerical Designator for the character you want, then press ▶. See Appendix B of this manual for a list of available characters and their numeric designators.

9. Repeat step 8 until the name is complete.

10. Press  when the name is complete.

7.4.1.2 Edit Zone Properties

Zone properties consist of, alarm delay characteristics, and heat detector sensitivity.

1. Do steps 1 through 6 of Section 7.4.1.
2. Press  to edit the properties of the selected zone.

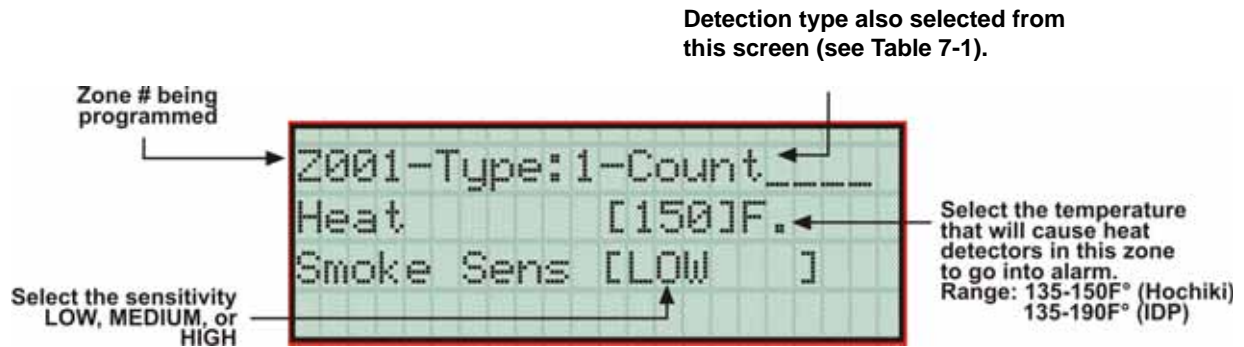

Alarm Delay Characteristics

3. Select the alarm delay characteristics by pressing the  or  arrow.

Table 7-1 list the delay choices and a description of each.

Table 7-1: Alarm Delay Types

Type of Delay	Description
1-Count	One Count (No Delay). When this option is enabled, an alarm occurs immediately when a single device of any of the following types goes into alarm: detector, manual pull, water flow, Aux1 or Aux2. This is considered the most typical operation and is the default for all zones.
2-Count	When this type of alarm delay is used, two or more detectors within the zone must go into alarm in order for the zone to report an alarm. Switches of type manual pull, water flow, Aux1 and Aux2 are an exception; they will cause an alarm when only one switch is in alarm. When a single detector is in alarm in a 2-Count zone, the system enters a prealarm condition. In a prealarm condition, the touchpad PZT beeps and the annunciator display indicates that a prealarm has occurred. If the zone has been mapped to an output group for the prealarm event, the output group will activate. The prealarm will not be reported to the central station.

Table 7-1: Alarm Delay Types

Type of Delay	Description
Alarm Ver.	Alarm verification is an optional false alarm prevention feature that verifies an alarm condition by resetting the smoke detector. If the alarm condition still exists by the time the reset cycle has completed, the detector will go into alarm. If the detector is no longer in alarm, no report will go to the central station. The alarm verification sequence is ignored if the zone is already in alarm.
PAS	<p>This option is intended to be used with an acknowledge switch. An alarm is delayed for 15 seconds, giving on-site personnel a chance to investigate the alarm. If the acknowledge switch is not activated within 15 seconds, an alarm occurs automatically.</p> <p>If this option is enabled for a zone, the zone will respond to an alarm condition as follows:</p> <ul style="list-style-type: none"> • The zone will not go into alarm for 15 seconds to allow an on-site operator to activate the acknowledge switch. • If the operator does not press the acknowledge switch within 15 seconds, the zone will go into alarm. • If the operator presses the acknowledge switch within 15 seconds, a 180-second time-frame will begin counting down. This time-frame allows the operator to investigate the cause of the alarm. <p>If the operator performs a reset within 180 seconds, the alarm will not occur.</p> <p>If the operator does not perform a reset within 180 seconds, an alarm will occur automatically.</p> <ul style="list-style-type: none"> • The P.A.S. feature will be overridden if another alarm occurs.
SNGL ILOCK	See Section 8.6.1 for single interlock releasing operation.
DBL ILOCK	See Section 8.6.2 for double interlock releasing operation.

4. Press .

Heat Detector Sensitivity

Use this feature to set the temperature at which high temperature detectors will respond. All detectors in the zone will respond in the same way. The range for the SD505-AHS heat detector is from 135°F to 150°F. The range for IDP-Heat-HT heat detector is from 135°F to 190°F.

The high temperature IDP heat detectors are absolute temperature devices. This means that they respond to an alarm immediately if the temperature in the zone goes above the programmed temperature.

- Enter the temperature at which the heat detector will respond.

Or

Use the ▼ or ▲ keys to scroll through the range or enter directly from the number keys on the annunciator, then press .

Smoke Detector Sensitivity

IMPORTANT!

Drift compensation is automatic for all smoke detectors (photoelectric and ionization). The feature is always in effect, no programming is required. See Section 8.4.12 for information about how to check if a detector is in UL compliance.

All detectors in the zone will respond as programmed in this menu location.

Table 7-2: Hochiki & IDP Detector Sensitivity Choices*

Detector Protocol	Type of Smoke Detector	Choices	Comments
Hochiki	SD505-APS	Low (3.5% obscurity)	If the day/night sensitivity option is selected, you can have different sensitivity settings during the day and at night. You can determine the days of the week that Day/Night Sensitivity will automatically adjust. You can also designate specific days as Holidays. Holiday and weekend days use night sensitivity for the entire day
		Medium (2.5% obscurity)	
		High (1.5% obscurity)	
	SD505-AIS	Fixed	Sensitivity for ionization detectors is always 64 MIC (1.1% obscurity per foot) regardless of Low, Medium or High setting. Day and night settings also have no effect on these detectors.
	SD505-ADH with SD505-APS	Fixed	Low, Medium and High settings have no effect for photoelectric duct detectors. Photoelectric duct detector sensitivity is always 1.1% per foot. Day and night settings also have no effect on these detectors.
SD505-ADH with SD505-AIS	Fixed	Low, Medium, or High settings have no effect for ionization duct detectors. Ionization duct detector sensitivity is always 75 MIC (0.8%) regardless of Low, Medium or High setting. Day and night settings also have no effect on these detectors.	

Table 7-2: Hochiki & IDP Detector Sensitivity Choices*

Detector Protocol	Type of Smoke Detector	Choices	Comments
IDP	IDP-Photo, IDP-Acclimate, & IDP-Photo-T	Low (3.5% obscurity)	If the day/night sensitivity option is selected, you can have different sensitivity settings during the day and at night. You can determine the days of the week that Day/Night Sensitivity will automatically adjust. You can also designate specific days as Holidays. Holiday and weekend days use night sensitivity for the entire day
		Medium (2.5% obscurity)	
		High (1.5% obscurity)	
	IDP-Ion	Low (55 pA)	
		Medium (68 pA)	
		High (80 pA)	
	IDP-Pduct & IDP-Pduct-R	Low (2.5% obscurity)	
		Medium (2.0% obscurity)	
		High (1.5% obscurity)	

* Automatic drift compensation is always in effect for all detectors. See Section 8.4.12 for information about how to check if a detector is in compliance.

6. Use the ▼ or ▲ keys to scroll through the range or enter directly from the number keys on the annunciator.
7. Then press .

7.4.1.3 Zone Outputs

Output groups and cadence patterns are mapped to events. They can be programmed to output when an event occurs in a zone. Some system trouble events can be mapped for the entire system. Section 6.2 of this manual contains a general explanation of mapping. The following sections explain how to select mapping options.

Zone Mapping to Voice Output Groups

When a voice output group is selected to be activated by a zone, the cadence pattern choice listed in Section 7.4.1.4 do not apply. For voice output groups, one of six system wide voice commands will activate instead of the cadence pattern. Which command is determined by the event type selected for that zone. The six commands are programmable by the installer (see Section 7.7.10 for more information). Table 7-3 lists the six different commands and the associated event type.

Table 7-3: Event Types for Voice Commands

Command	Event Type	Comments
Command 1	Fire	It will sound whenever a request is made to activate a voice output group that was triggered from a manual pull, detector, or water flow event.
Command 2	Auxiliary 1	See <i>Mapping to Zone Events</i> below.
Command 3	Auxiliary 2	
Command 4	Pre-alarm	
Command 5	Supervisory	
Command 6	Trouble	

Note: Use of multiple notification groups may not synchronize with each other.

Mapping to Zone Events

Eight types of events can occur in zones. For each event type, you can activate up to 8 output groups or output group template, specifying a pattern for each. The following is a list of all event types:

Note: Abbreviations in parentheses are the characters that are displayed in programming.

- Manual Pull Alarm (MP)
- Water Flow Alarm (WF)
- Detector Alarm (DE). This applies to heat or smoke detectors.
- Aux 1 and Aux 2 Alarm (A1 or A2). User-specified alarm types.
- Pre-alarm (PR)
- Supervisory (SU)
- Trouble (TR)

To map zone events to outputs, follow these steps:

1. From the Installer Main Menu, select **7** for Program Menu.
2. From the Program Menu, select **2** for Zone.
3. From the next menu, select **1** for Edit Zone.
4. Enter the zone number you wish to edit.
5. From the next menu, select **3** for Zone Outputs.
6. From the next screen, a list of 8 event types will display. Select the event type you want to program. A screen similar to the one shown in Figure 7-3 will display. Press **ENTER**.
7. Press the **▽** or **△** key to toggle the group letter to either G = Group or T = output group template depending on what you need for this zone. Press **ENTER**.
8. Select options for each event that could occur in this zone. Figure 7-3 is a complete example of how you might map a zone.

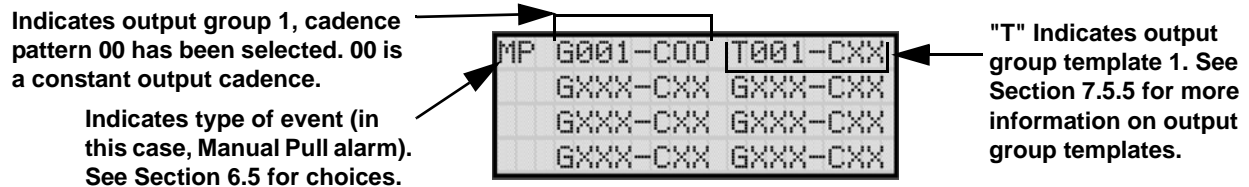

Figure 7-3 Selecting Output Groups/Templates and Cadence Patterns for a Zone Event

Zone Mapping Example

Suppose you want to program Zone 1 so that:

- Any alarm (detector, water flow or manual pull) would activate Output Group 1 using the ANSI cadence pattern.
- Manual pull alarm would activate Output Group 3 using constant output.
- Troubles would activate Output Group 2 using the zone-coded cadence pattern.

To accomplish this you need to access the screen for each event and then select your output groups. Figure 7-4 shows how you would program this application.

For this application:

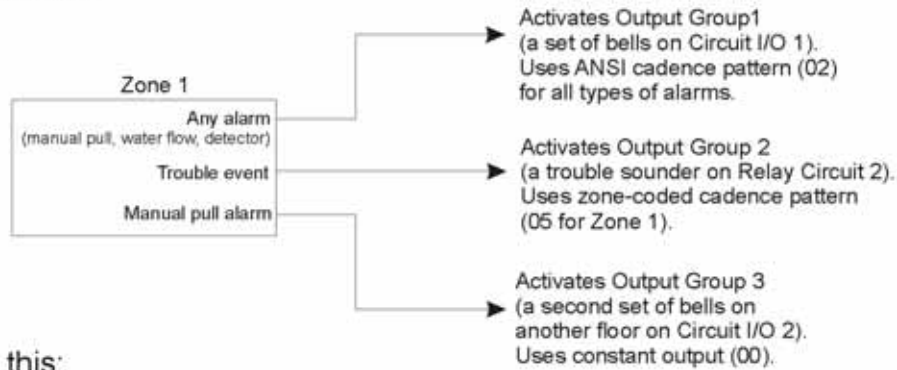

Program like this:

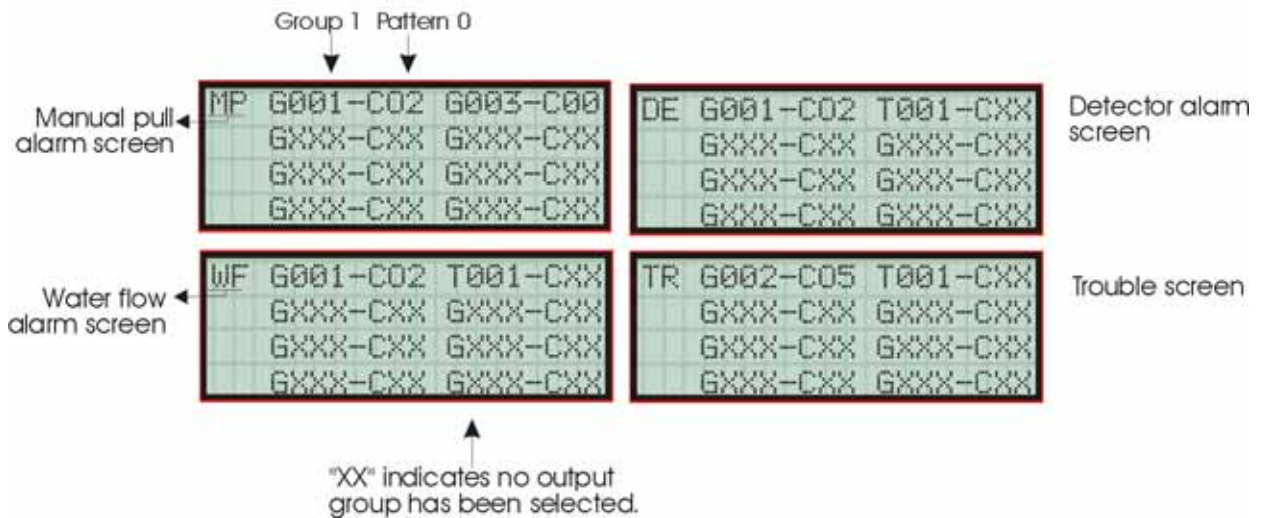

Figure 7-4 Zone Mapping Example

7.4.1.4 Cadence Patterns

The cadence patterns shown in Figure 7-5 are available for use with the control panel.

Cadence patterns can be selected by event type for each zone or for the entire system. Special cadence patterns can be selected for fire drills and any auxiliary system switches used with the system.





#	Name	Pattern Description																										
00	Constant	Continuous sound Patterns repeat until condition is cleared. Note: This is the only pattern that can be used for relay circuits. The system will override any other choice.																										
01	March Code	 .5 sec on .5 sec off																										
02	ANSI 3.41	 .5 sec on 1.5 sec off																										
03	Single Stroke	 .1 sec on 3 sec off 1 sec off																										
04	California	 5 sec. on 10 sec. off																										
05 ⋮ 16	Zone Coded	<table border="1" data-bbox="341 1113 576 1449"> <thead> <tr> <th>Pattern#</th> <th>Zone</th> </tr> </thead> <tbody> <tr><td>5</td><td>Zone 1</td></tr> <tr><td>6</td><td>Zone 2</td></tr> <tr><td>7</td><td>Zone 3</td></tr> <tr><td>8</td><td>Zone 4</td></tr> <tr><td>9</td><td>Zone 5</td></tr> <tr><td>10</td><td>Zone 6</td></tr> <tr><td>11</td><td>Zone 7</td></tr> <tr><td>12</td><td>Zone 8</td></tr> <tr><td>13</td><td>Custom 1</td></tr> <tr><td>14</td><td>Custom 2</td></tr> <tr><td>15</td><td>Custom 3</td></tr> <tr><td>16</td><td>Custom 4</td></tr> </tbody> </table>  .5 sec on .5 sec off → This pattern multiplied by # of zone in alarm, followed by 3 seconds off. EXAMPLE: Pattern 06, Zone 2 coded  Zone 1 Zone 2 Off Zone 1 Zone 2	Pattern#	Zone	5	Zone 1	6	Zone 2	7	Zone 3	8	Zone 4	9	Zone 5	10	Zone 6	11	Zone 7	12	Zone 8	13	Custom 1	14	Custom 2	15	Custom 3	16	Custom 4
Pattern#	Zone																											
5	Zone 1																											
6	Zone 2																											
7	Zone 3																											
8	Zone 4																											
9	Zone 5																											
10	Zone 6																											
11	Zone 7																											
12	Zone 8																											
13	Custom 1																											
14	Custom 2																											
15	Custom 3																											
16	Custom 4																											
17 ⋮ 21	<table border="1" data-bbox="341 1470 625 1606"> <thead> <tr> <th>Pattern #</th> <th>Sync Type</th> </tr> </thead> <tbody> <tr><td>17</td><td>Faraday</td></tr> <tr><td>18</td><td>Gentex</td></tr> <tr><td>19</td><td>System Sensor</td></tr> <tr><td>20</td><td>Wheelock</td></tr> <tr><td>21</td><td>AMSECO</td></tr> </tbody> </table>	Pattern #	Sync Type	17	Faraday	18	Gentex	19	System Sensor	20	Wheelock	21	AMSECO	These outputs provide synchronization for AMSECO, Faraday, Gentex, System Sensor, or Wheelock synchronized appliances.														
Pattern #	Sync Type																											
17	Faraday																											
18	Gentex																											
19	System Sensor																											
20	Wheelock																											
21	AMSECO																											

Figure 7-5 Cadence Patterns Available with the Control Panel

7.4.1.5 Zone Accessory Options

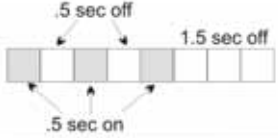
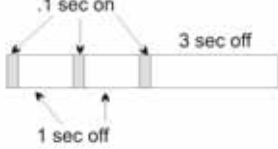
This option applies to detectors that are used with SD505-6SB, SD505-6RB, and SD505-

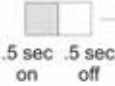

ADHRs.

Single or Multi-station cadence pattern (choose from Patterns 00 to 21).



Local Zone (choose Y or N, for Yes or No).

7.4.2 Add Zone

To add a zone, follow these steps:

1. Press  or  to display the main menu.
2. Select  for Program Menu.
3. Enter code if prompted.



```
Display reads:           Initializing
                    Please wait . . .
```

4. Press  to enter zone menu.
5. Press  to add a zone.

A zone will be added. The system will assign the next available zone number. Options for this zone can now be programmed through the Zone Edit sub-menu. Up to 125 zones can be used.

7.4.3 Delete Zone

To delete a zone, follow these steps:

1. Press  or  to display the main menu.
2. Select  for Program Menu.
3. Enter code if prompted.

```
Display reads:           Initializing
                    Please wait . . .
```

4. Press  to enter zone menu.

5. Press to delete a zone.

A warning screen will display. If you want to proceed with deleting the zone, select Yes.
To cancel, select No.

7.4.4 View Zone Points

To view the points in a zone, follow these steps:

1. Press **▶** or **ENTER** to display the main menu.
2. Select **7** for Program Menu.
3. Enter code if prompted.

Display reads: Initializing
 Please wait . . .

4. Press **2** to enter zone menu.
5. Press **4** to view zone points.
6. Enter the number of the zone you wish to view, then press **ENTER**.

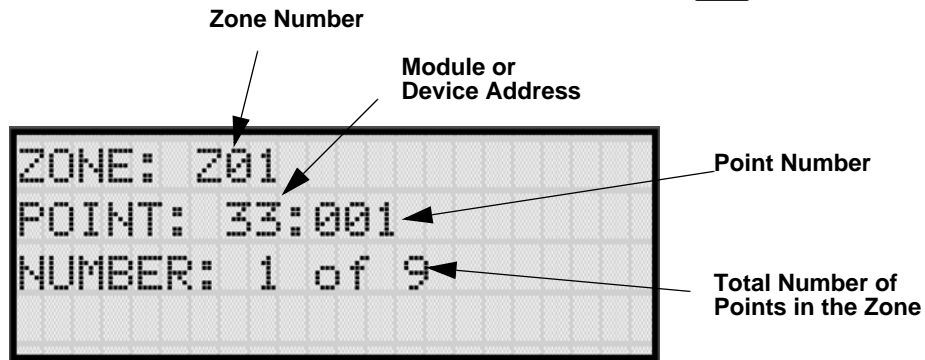

Figure 7-6 View Zone Points Screen

7.5 Group



An output group is made up of output points that have been programmed to respond in the same way. Output groups simplify programming because you have to program the output characteristics that are common to all of the group points once, instead of programming each individual point. Once you have defined the characteristics of output groups, you can assign each point to the appropriate group. All valid output points are assigned to only one output group. Unused points are not assigned to any output group. Up to 250 output groups can be defined.

Each output group is defined as either a voice output group or a non-voice output group. Output points that are audio circuits (all circuits on the VIP-50 and VIP-CE4) can only be assigned to voice output groups. Output points that are non-voice circuits (all other points and circuits that are on all modules except the VIP-50 and VIP-CE4) are assigned to non-voice output groups.



7.5.1 Edit Group

In the edit group option you can program the name of an output group (Section 7.5.1.1) and change the properties (Section 7.5.1.2) of that group.

To edit a group, follow these steps:

1. Press  or  to display the main menu.
2. Select  for Program Menu.
3. Enter code if prompted.

```
Display reads:           Initializing
                       Please wait . . .
```

4. Press  to enter group menu.
5. Press  to edit group.
6. Enter the number of the group you wish to edit, then press .

7.5.1.1 Edit Group Name

7. To edit the group name, press **[1]**. A screen similar to the one shown in Figure 7-7 displays.

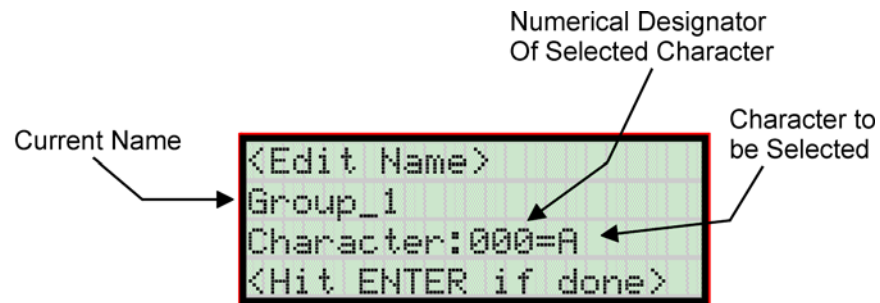

Figure 7-7 Selecting Character for Zone Name

8. Select the characters for the zone name by pressing the **▲** or **▼** arrow until the desired character is shown then press **▶**.

OR

Enter the Numerical Designator for the character you want, then press **▶**. See Appendix B of this manual for a list of available characters and their numeric designators.

9. Repeat step 8 until the name is complete.
10. Press **ENTER** when the name is complete.

7.5.1.2 Edit Group Properties

The Edit Group Menu allows you to select options for each group for the following items:

- Latching or non-latching outputs.
- Silencing operation.
- Operation with system switches.
- Define output group type as voice or non-voice. See option for Voice EVAC Only in

Figure 7-8.

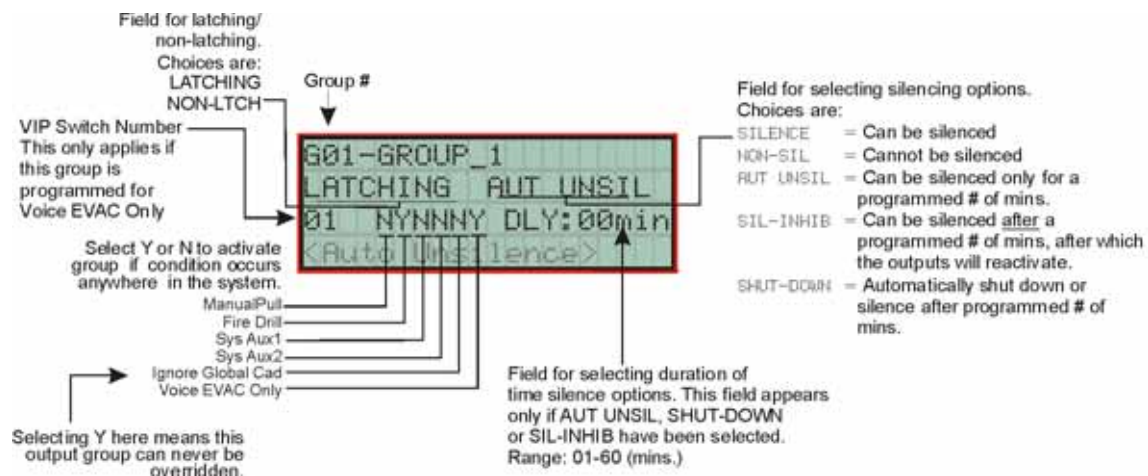

Figure 7-8 Group Properties Screen Programming Options

Latching / Non-latching Outputs

Outputs that are programmed as Latching remain active until the system has been manually reset. Non-latching outputs stop activating automatically when the condition clears.

Silencing Options

The following silencing options are available for each output group.

Table 7-4: Silencing Options

Option	Description
SILENCE	Silenceable. The output group can be silenced through the SILENCE key.
NON-SIL	Not silenceable. The output group cannot be silenced. Activation of the SILENCE key will be ignored for this output group.
AUT UNSIL	Auto Unsilenced. If this option is selected, the output group can be silenced for a programmed time-frame. If the condition that caused the output to activate has not cleared during the time-frame, the output reactivates. If you select this option, select the time-frame in the DLY: field. Range is 01-60 minutes. (See Figure 7-8 for location of field.)
SIL-INHIB	Timed Silence after Inhibit. If this option is selected, the output group must be audible for a programmed number of minutes before it can be silenced. If the condition that caused the output to activate has not cleared during the time-frame, the output can be silenced. If you select this option, select the timeframe in the DLY: field. Range is 01-60 minutes. (See Figure 7-8 for location of field.)
SHUT-DOWN	If this option is selected, the output group will automatically silence (shut down) after the programmed time period. If you select this option, select the timeframe in the DLY: field. Range is 01-60 minutes. (See Figure 7-8 for location of field.)

Response with System-Wide Conditions

You can select whether an output group will respond to various system-wide occurrences.

(See Figure 7-8 for location of this field.)

Table 7-5: Output Group Response Choices

Option	Description
ManPull	<p>Manual Pull Activation. Select Yes if you want this group to activate for all manual pull alarms that occur in the system.</p> <p>Note: Even though manual pull switches are assigned to zones, activation selected here for manual pull will override zone-programmed activation.</p>
Fire Drill	<p>Fire Drill Activation. Select Yes if you want this group to activate for fire drills.</p>
Sys Aux1 and Sys Aux2	<p>Select Yes if you want this output group to activate for system-wide Aux1 and Aux2 alarms.</p> <p>(Aux 1 and Aux 2 alarm types are for auxiliary alarm conditions. For example, you might want to use Aux 1 to provide a unique alarm type.)</p>
Ignore Global Cad	<p>Ignore Global Cadence. If you want to create an output group that can never be overridden, you can select Yes for this option. Selecting No means that system-wide events that have been assigned an output pattern could override the pattern for the output group.</p> <p>For example, suppose you had assigned a set of strobes to Output Group 3. You would never want these strobes to output in a pattern under any circumstances. To make sure this happens, select Yes for Ignore Global Cadence for Output Group 3.</p>
Reverse Polarity	<p>This option programs the output group for reverse polarity operation.</p> <p>Selecting Reverse Polarity -Troubles for polarity reversal connections will cause the output group to be de-energized for any system trouble.</p> <p>Selecting Reverse Polarity - No Troubles for city box (auxiliary) connections will cause system troubles to be ignored, but all troubles will still be annunciated locally.</p> <p>Activation is accomplished through standard mapping methods. Use with the 7644 assembly to implement reverse polarity. See Section 4.15.3.2 for more information on the 7644.</p>

Define Output Group Type

Each output group is defined as either a voice output group or a non-voice output group. Output points that are audio circuits (all circuits on the VIP-50 and VIP-CE4) can only be assigned to voice output groups. Output points that are non-voice circuits (all other points and circuits that are on all modules except the VIP-50 and VIP-CE4) are assigned to non-voice output groups.

Each of the output groups defined as voice can be mapped to a particular Switch and LED on the VIP-VCM and VIP-SW16. Figure 7-9 illustrates how the numbers selected correspond to the VIP-VCM and -SW16.

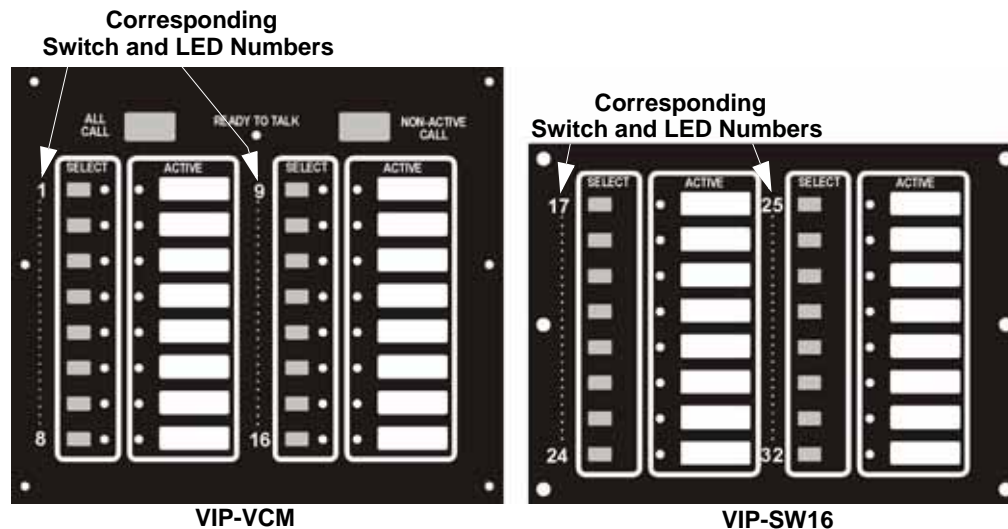







Figure 7-9 Corresponding Switch and LED for Mapping Output Groups

11. To get to this menu item repeat steps 1 through 6 of section 7.5.1.
12. To edit group properties, press **[2]**.
13. Press the **▽** or **△** arrows to select the desired latching option.
14. Press **ENTER**.
15. Press the **▽** or **△** arrows to select the desired silencing option. Refer to Table 7-4.
16. Press **ENTER**.
17. Enable group activation for a condition (see Table 7-5) by pressing the **▽** or **△** arrows to select Y (yes) or N (no).
18. Press **ENTER**.
19. Repeat steps 14 and 15 for all the activation options.

7.5.2 Add Group

To add a group, follow these steps:

7.5.4 View Group Points

1. Press  or  to display the main menu.
2. Select  for Program Menu.
3. Enter code if prompted.
Display reads: Initializing
 Please wait . . .
4. Press  to enter group menu.
5. Press  to view group points.
6. Enter the group number, then press .

```
GROUP: G01
POINT: 01:001
NUMBER: 1 of 12
```

7.5.5 Edit Output Group Templates

Some installations may require that zones be mapped to more than 8 output groups. With output group templates you can combine one or all output groups into one template, which can be used when the same combination of outputs are used for several zones.

For example, lets say an installation has five zones (See table below). The check mark indicates what output groups are mapped to each zone. You will notice that every zone is mapped to outputs 1 and 2. As an alternative you can create a template that combines output group 1 and 2 as one choice.

Zone	Group Number							
	1	2	3	4	5	6	7	8
1st Floor Smoke Detectors	✓	✓			✓			
2nd Floor Smoke Detectors	✓	✓			✓			
3rd Floor smoke Detectors	✓	✓			✓			
Manual Fire Pull Stations	✓	✓					✓	
Water Flow Switches	✓	✓						✓

This can be done by creating a template which includes output groups 1 and 2. Then you can map all the zones to the template you created. This will free up output group assignments that are common to several zones. This is very useful when you need to map zones to more than eight output groups.

To create Output Group Templates:

1. From the Main Menu, select **7** for Program Menu.
2. From the Program Menu, select **3** for Group.
3. At the next screen, select **5** for Edit OPG Template.
4. Select the template number (01 - 08).
5. Select output group number. See Figure 7-10.

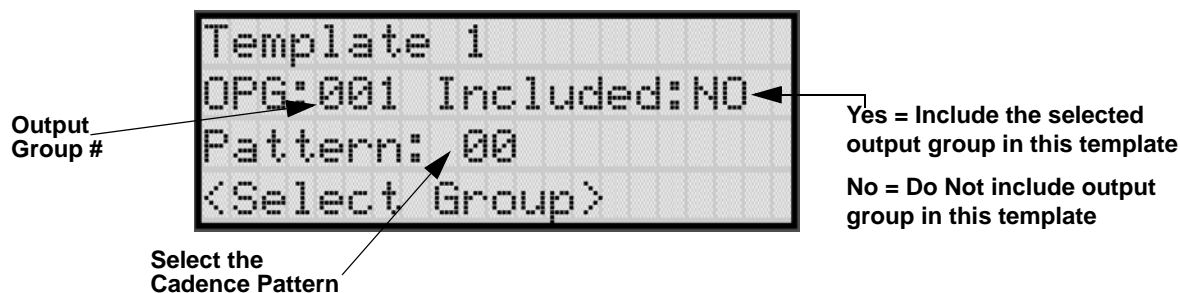

Figure 7-10 Output Group Template Programming Screen

7.6 Point

You may need to change characteristics of individual input points (detectors and switches) even after using JumpStart. This section explains how to change options for: type of input point; latching/non-latching status (switches); and name and zone assignment of a point.

7.6.1 Point Programming for the SLC

To program for points, follow these steps:

1. Press **▷** or **ENTER** to display the main menu.
2. Select **7** for Program Menu.
3. Enter code if prompted.

Display reads: Initializing
 Please wait . . .
4. Press **4** to enter point menu.
5. Press the **▽** or **△** arrows to select the desired module, then press **ENTER**. Refer to Section 6.5 Quick Reference Table for available choices.
6. Enter the number of the point you wish to edit, then press **ENTER**.
7. Select the type of device by pressing the **▽** or **△** arrows. Refer to Table 7-6 under column heading "Type Selection" for a list of choices. Where applicable, features that apply only to Hochiki or IDP devices are noted in the Comments section.

Table 7-6: Point Programming



















Module Type	Type Selection	Function	Latching Option	Comments	
SLC Loop	UNUSED				
	DETECTOR	PHOTO			
		ION			
		HEAT			
		PHOT DUCT			
		ION DUCT		Hochiki devices only	
		2WIRE SMK			
		Acclimate		IDP devices only	
		Heat HT			
		Photo-Heat			
		Beam			
	SUP DET	SUP PHOTO	Latching		
		SUP ION	Non Latching	Hochiki devices only	
	SWITCH	MAN_PULL			Use this switch type for manual pull stations. This input is always latched. The switch can clear only when an alarm is reset. This switch type has the highest priority; it overrides any other type of alarm.
		WATERFLOW	Latching		Use this switch type for monitoring water flow in a sprinkler system. Switch closure will cause a sprinkler alarm. Water flow switches can be programmed as latching or non-latching. You can program a delay of up to 90 seconds to be used with a water flow switch. The delay allows for normal, brief changes in sprinkler system water pressure. The water flow alarm will not activate unless the switch is active for the programmed delay time. Note: Waterflow delay of the FACP and the waterflow device shall not exceed 90 seconds.
			Non Latching		If a delay is used, the system begins counting down when the switch closes. If the switch opens (restores) before the timer expires, a water flow alarm is not generated. If the water flow switch remains closed after the timer expires, a water flow alarm will be generated.
		SUPERVISY	Latching		Use this switch type for tamper monitoring of sprinklers and other fire protection devices. If a contact closes, a sprinkler supervisory event will be generated. Supervisory switches can be latching or non-latching.
			Non Latching		
		FIREDRILL			System-level, non latching switch. This switch is an alternative way of causing a fire drill. It has the same operation as the fire drill option available from the annunciator. When the switch is activated, a fire drill begins; when the switch is de-activated, a fire drill ends.
		SILENCE			System-level switch provides an alternate way to silence the system; same effect as pressing the Silence key.
		RESET			System-level switch provides an alternate way to reset the system; same effect as pressing the Reset key.

Table 7-6: Point Programming

Module Type	Type Selection	Function	Latching Option	Comments	
SLC (cont.)	SWITCH (cont.)	PAS_ACK		Positive acknowledge switch. This switch must be used in zones programmed as Positive Alarm Sequence (see Table 7-1). If an acknowledge switch closes when an alarm or trouble condition is not already in progress, a trouble will occur. You must use a UL listed normally open, momentary switch type. The switch must be rated at 5V, 100 mA (minimum) and be used with an EOL resistor for supervision.	
		ZN_AUX1	Latching	Use these switch types if you want to monitor special zone-level conditions (such as operation of a fan or damper).	
			Non Latching		
		ZN_AUX2	Latching		
			Non Latching		
		SYS_AUX1	Latching		Use these switch types if you want to monitor special system-wide conditions (such as operation of a fan or damper).
			Non Latching		
		SYS_AUX2	Latching		
			Non Latching		
		DETECT SW		Used to monitor conventional 4-wire detectors, a contact closure will generate a detector alarm event.	
		TAMPER	Latching	Performs identically to a supervisory switch, but will be indicated as a tamper switch on the LCD annunciator.	
			Non Latching		
		MAN REL	Latching	Manual release switch, typically a pull station.	
	Non Latching				
	ILOCK	Latching	Interlock release switch input.		
		Non Latching			
	NOTIF	OUTPUT PT	Select Group		
		AUX CONST		Use for auxiliary power applications where the devices require constant power.	
		AUX RESET		Use for auxiliary power, resettable applications. See Section 4.13.2.3 for a description of how this option operates.	
		AUX DOOR		Use for auxiliary power, door holder applications. For example, if you were using an auxiliary power supply for door holders, you would use this option. See Section 4.13.2.1 for a description of how this option operates.	
	RELAY	OUTPUT PT	Select Group	Output Point, a general use relay type. Use for applications requiring a relay, such as fan shutdown, elevator recall, and so on.	
		AUX RESET	Select Group	Use for auxiliary power, resettable applications. See Section 4.13.2.3 for a description of how this option operates.	
		AUX DOOR	Select Group	Use for auxiliary power, door holder applications. For example, if you were using an auxiliary power supply for door holders, you would use this option. See Section 4.13.2.1 for a description of how this option operates.	
	SLC LED	Select LED No.	UNUSED		
			NOTIF	When NOTIF is selected you must then select the output group number.	

7.6.2 Point Programming For Internal or External Power Module (5496)

To program for an internal or external power module points, follow these steps:

1. Press  or  to display the main menu.
2. Select  for Program Menu.
3. Enter code if prompted.
 Display reads: Initializing
 Please wait . . .
4. Press  to enter point menu.
5. Press the  or  arrows to select the desired module, then press . Refer to Section 6.5 for available choices.
6. Enter the number of the circuit or point you wish to edit, then press . Refer to Table 7-6 for available selections.
7. Select the type by pressing the  or  arrows, then press .
8. Select the function by pressing the  or  arrows, then press .
9. Select the group by pressing the  or  arrows, then press .
10. Edit point name, or press  to skip point name edit. See Section 7.6.3.1.
11. Repeat Steps 1 through 15 for all circuits.

Choices	Type Selections	Function Selections for each Type	Comments
Enter Point or Circuit			
Select Type	UNUSED		
	B NOTIF		
	A NOTIF		
	AUX PWR	CONSTANT RESETTABLE DOOR	Constant auxiliary power. Resettable auxiliary power. Door holder auxiliary power.
Select Group			Group or Zone selection will appear depending on the type selected.
Edit Name			See Section 7.3.1.1.

7.6.3 Point Programming For 5880, 5865, VIP-50, and VIP-CE4 Modules

To program 5880, 5865, VIP-50, or VIP-CE4 module points:

1. Enter the installer code.
2. Press \blacktriangleright or ENTER to display the main menu.
3. Select $\boxed{7}$ for Program Menu.
Display reads: Initializing
 Please wait . . .
4. Press $\boxed{4}$ to enter point menu.
5. Press the ∇ or \triangle arrows to select the desired module. Refer to Section 6.5 for available choices.
6. Press ENTER .

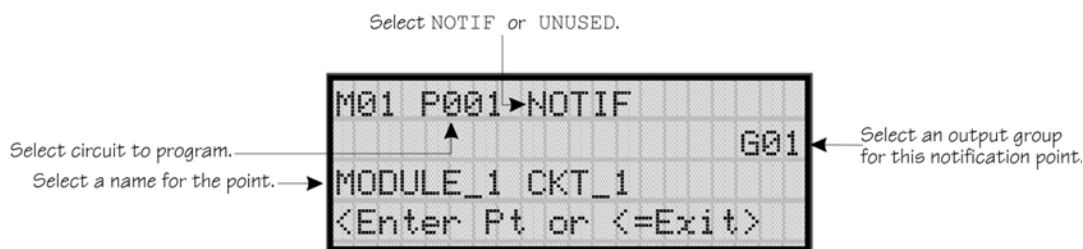



Figure 7-11 Programming Points Screen for 5880 and 5865 Modules

7. Enter the point number.
8. Press ENTER .
9. Press the ∇ or \triangle arrows to select the type (Notification or unused).
10. Press ENTER .
11. Press the ∇ or \triangle arrows to select the desired Group.
12. Press ENTER .
13. Edit module name. See Section 7.6.3.1.
Or
Press \blacktriangleright to skip module name edit.
14. Repeat Steps 1 through 13 for all points.

7.6.3.1 Assigning a Name to a Point

You can assign a name to a point to make it easier to recognize on a display.

If you wish to edit the name of a point, follow these instructions:

1. Do steps 1 through 4 of Section 7.6.3.
2. Using the \blacktriangle or \blacktriangledown arrow, select the module of the point you want to edit, press .
3. Enter the point number.
4. Press \blacktriangleright until the module name is blinking.
5. Press .

A screen similar to the one shown in Figure 7-2 displays.

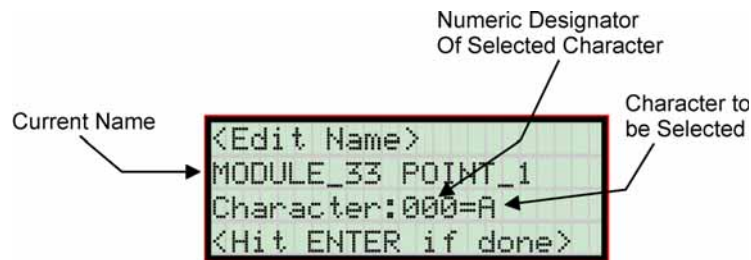



Figure 7-12 Selecting Character for Zone Name

6. Select the characters for the point name by pressing the \blacktriangle or \blacktriangledown arrow until the desired character is shown then press \blacktriangleright .

OR

Enter the Numerical Designator for the character you want, then press \blacktriangleright . See Appendix B of this manual for a list of available characters and their numeric designators.

7. Repeat step 6 until the name is complete.
8. Press  when the name is complete.

7.7.1.1 Edit Accounts

- From the next menu, select for Edit Account.

A screen similar to one shown in Figure 7-13 will display. The following subsections describe the options on each field.

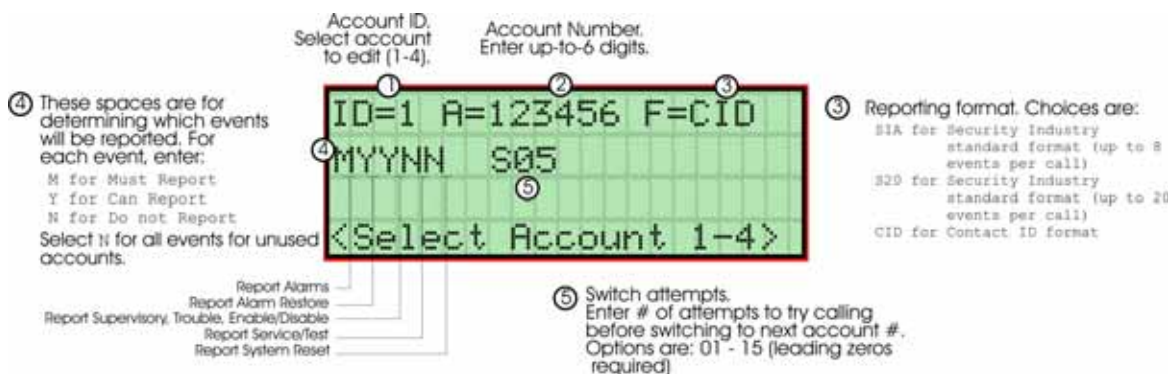

Figure 7-13 Reporting Account Editing Screen

Select Account (ID)

The control panel provides up to 4 reporting accounts. The priority of an account is based on its account ID. Account 1 is highest priority; Account 4 is lowest. Use Account 1 to report the highest priority events.

- Press the or arrow to select account ID number, then press .

Edit Account Number



Enter an up-to-6-digit number for each account to identify the account to the central station. See Figure 7-13 for location of this option on the screen. The account number should be compatible with the reporting format used. For example, the Contact ID format transmits up to four digits only.

- Enter the desired account number (up to 6-digits), then press .

Select Reporting Format

Select a reporting format for each account. Options are:



SIA	SIA format. 8 events per call.
CID	Ademco's Contact ID format
S20	Same as SIA but limits events reported to 20 events per phone call.

9. Press the  or  arrow to select the reporting format, then press .

Events to Report

The next six options select which types of events (or event families) will be reported to this account. (See Figure 7-13 for location of these options on the screen.) Events are reported by zone.

Event Family	Events Included in this Family
Alarms	All alarms (Water Flow, Manual Pull, Detectors, Auxiliary Switches)
Alarm Restore	All alarm restores.
Supervisory, Trouble, Enable/ Disable Point	All trouble and supervisory conditions and trouble and supervisory restores. Enabling and disabling of input and output points.
Service/Test	Fire drill, walk test, dialer test, automatic test, all programming sessions.
System Reset	All system resets.

10. Press the  or  arrow to select Must, Yes, or No (see Table below), then press .



11. Repeat step 10 for all five event report options.

For each event family, select M, Y, or N.

M(ust)	Must Report. Selecting "M" makes this a primary reporting account for this family of events. The dialer MUST report events in this family to this account. Selecting Must makes an account a primary reporting account. The dialer will try to report the event to the primary account until it exceeds the "Switch Attempts" value. When the dialer has exceeded the Switch Attempt retry limit, it will switch to a backup account (a "Can Report" or "Yes" account, see below). If the dialer cannot report the event to any of the backup accounts, it will return to the primary account and repeat the process until it exceeds the "Fail Attempts" value. If the Fail Attempts limit is exceeded, an Account Trouble condition is generated and a local trouble will sound.
Y(es)	Can Report. Selecting Y makes this a backup account for this event family. The dialer will report to this account only if it was previously unable to report the event to a Must account.
N(o)	No events in this family will ever be reported to this account.

Switch Attempts

Specify the number of times the dialer should attempt to report to this account before switching to the next account. Range is 01-15.

12. Enter the number of switch attempts (or press the  or  arrow), then press .



7.7.2.2 Number of Answer Rings

This option is used in conjunction with the Silent Knight Software Suite 5650/5651. Use the option to determine the number of rings before the panel answers a call from the computer. Range is 00-15 rings. This option is factory-programmed as 06 rings, which should be compatible for most installations where the answering machine bypass feature is used. You may need to adjust it depending on the installation's telephone system.

The selection made here must match the programming for this option in the Communication Configuration dialog box of the 5650/5651 software. See the SKSS manual for more information (PN 151239).



8. Enter the desired number of answer rings, then press .

7.7.2.3 Dial Option (TouchTone or Pulse)

9. Press the  or  arrow to select the dial option, then press .

Dial Option	Description
PULSE	If this option is selected, only pulse dialing will be used for this phone line.
TT	TouchTone dialing. If this option is selected, only TouchTone dialing will be used for this phone line.
TT/PL	TouchTone alternating with pulse. If this option is selected, the dialer will first attempt to use TouchTone. It will switch to pulse if TouchTone is not successful on the first attempt. It will continue to alternate between TT and pulse for additional attempts.

7.7.2.4 Rotary Format

10. Press the  or  arrow to select the pulse ratio for rotary dialing option, then press

.

Options are:

- U U.S. standard format. Uses the 60 msec / 40 msec make/break ratio.
- E European format. Uses the 66 msec / 34 msec make/break ratio.

7.7.2.5 Line Monitor

Enable the line monitor for each phone line that will be used. See Figure 7-14 for location of this field on the phone lines screen. When the phone line monitor has been enabled for a phone line, a trouble condition will occur if the line is not connected. If a phone line will not be used, it must be disabled.

11. Select Y (monitor line) or N (don't monitor line) by pressing the  or  arrow, then press .

7.7.2.6 Ground Start Relay

If using the 5211 ground start relay, you must enable the ground start relay programming option. See Figure 7-14 for the location of this field on the phone lines screen. This option is disabled by default. For 5211 installation, see Section 4.12.

Note: Ground start cannot be used in UL installations.

12. Select Y (ground start used monitor line) or N (ground start not used don't monitor line) by pressing the ▲ or ▼ arrow, then press .

7.7.2.7 Answering Machine Bypass

This option is used in conjunction with the Silent Knight Software Suite 5650/5651. This feature ensures that an answering machine will not interfere with communication between the panel and the computer. If an answering machine is used at the panel site, enable this feature; if an answering machine is not used, disable the feature.

This option is factory-programmed as Yes (enabled).

The selection made here must match the programming for this option in the Communication Configuration dialog box of the 5650/5651 software. See the manual for the software (p/n 151240) if you need more information.

13. Select Y (answering machine bypass enabled) or N (answering machine bypass disabled) by pressing the ▲ or ▼ arrow, then press .

7.7.3.1 Trouble Events

You can map certain system trouble events to an output group. To access the screen for selecting output groups and cadence patterns for system trouble events.

- Press **[1]** for Trouble Events. A screen similar to the one in Figure 7-15 will display. Select a group and a cadence pattern for each event as needed for your application. The U: field is for a user-specified trouble condition. You can program an output group and cadence pattern for any of the following events:

Battery	Low battery condition.
Gnd Flt	Ground fault.
Phone Ln	Phone Line 1 or 2 trouble.
Account	Account trouble; cannot report to account.
Printer	Printer trouble. (Currently not supported; do not select.)
Aux Pwr	Auxiliary power trouble.
Sys Sw	Trouble with a system switch.
Group Tr	Trouble with an output group.
SBUS Com	SBUS communication trouble.
SBUS Pwr	SBUS power trouble.
SLC Loop	Trouble on the SLC loop.
AC Loss	AC power lost.

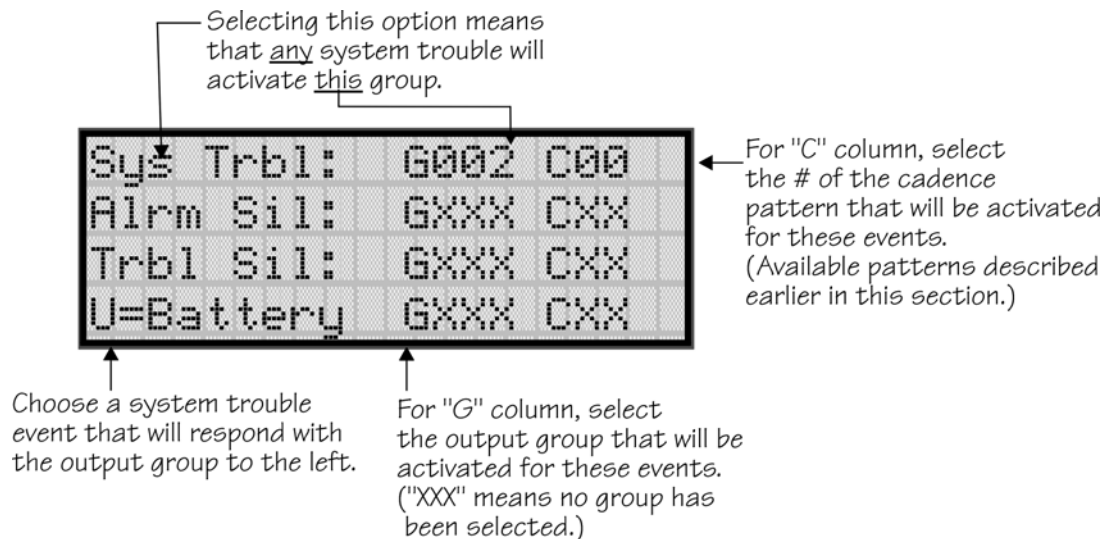

Figure 7-15 System Trouble Event Mapping Example

Note: Steps continued from step 6 of Section 7.7.6.1.

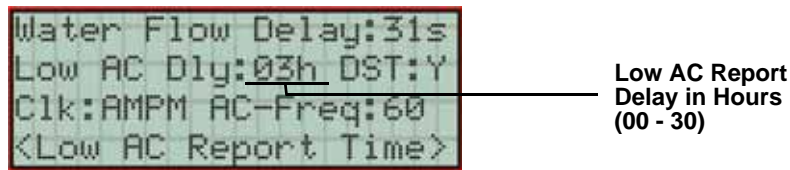

Figure 7-21 Low AC Report Delay Programming Screen

7. Enter the number of hours before a low AC report will be sent to the central station, then press . Refer to Figure 7-21.

7.7.6.3 Automatic Daylight Saving Time Adjustment

The control panel has an automatic DST (Daylight Saving Time) adjustment feature. Before January 2007, if this feature is enabled (set to *Yes*), the system clock will switch to DST on the first Sunday in April at 2:00 a.m. and revert to standard time on the last Sunday in October at 2:00 a.m. After January 2007, if this feature is enabled, the system clock will start and end DST according to the settings made in Misc. Options 3 (see Section 7.7.8.2). If this feature is not enabled (set to *No*) the Daylight Saving Time change is not made to the system clock.

To enable or disable DST adjustment continue programming from step 7 above:

8. Select Y (enabled) or N (disabled) by pressing the or arrow, then press .

7.7.6.4 Clock Display Format (AM/PM or Military)



To change the system clock display format, continue programming from step 8 above:

9. Select AMPM (for AM/Pm display format) or MIL (for military or 24 hr display format) by pressing the or arrow, then press .

7.7.6.5 Change AC Line Frequency

The panel's AC line frequency is selectable for 50, 60 Hz, or Neither. AC Frequency feature dictates how the control panel will calculate time based on the AC line frequency used in the installation site. The "Neither" option can be used in areas where the AC line frequency is not dependable and you want the panel to calculate time from the internal crystal. The internal crystal is not as accurate as the AC power source and either 60 Hz or 50 Hz should normally selected. The panel defaults to the 60 Hz. selection



To change the AC line frequency, continue programming from step 9 above:

10. Select 50, 60 or Neither, by pressing the  or  arrow, then press .



7.7.7 Miscellaneous Options 2

Through this programming option you can turn the strobe synchronization during silence feature On or Off, and select the control panel to report events by zone or by point.

To edit Miscellaneous Options 2:

1. Press  or  to display the main menu.
2. Select  for Program Menu.
3. Enter code if prompted.





```
Display reads:           Initializing
                    Please wait . . .
```

4. Select  for System Options.
5. Select  for Miscellaneous Options 2.

7.7.7.1 Synchronize Strobes Active During Silence

When "SYNC Strbs w/ Sil:" is Selected as Y (Yes) then strobes will continue to flash when the system is silenced and will stop flashing when the system is reset.





Note: The "SYNC Strbs w/ Sil:" only functions with outputs that use a synchronized output pattern.

6. Press the  or  arrow to toggle this selection between Y (Yes) or N (No).
7. Press  or  to make your selection and move to the next programming option.

Note: See Section 7.4.1.4 for more information about Synchronization protocol choices.





7.7.7.2 Auto Display Oldest Event

When this feature is programmed Y (Yes) then the oldest un-acknowledge event will automatically display on the control panel and remote annunciators after there has been no activity on any system touchpad for two minutes.

8. Press the  or  arrow to toggle this selection between Y (Yes) or N (No).
9. Press  or  to make your selection and move to the next programming option.

7.7.7.3 Report by Zone or by Point



When the "Report by" option is set to Zone, then the control panel will report events by zone. If Point is selected then the control panel will report events by point.

10. Press the  or  arrow to toggle this selection between Zone or Point.
11. Then press  or . See Section 9 for reporting codes.



7.7.8 Miscellaneous Options 3

From Miscellaneous Options 3, you set the alarm verification time and set the start and end week and month of Daylight Saving Time.

To edit Miscellaneous Options 3:

1. Press  or  to display the main menu.
2. Select  for Program Menu.
3. Enter code if prompted.



```
Display reads:      Initializing
                  Please wait . . .
```

4. Select  for System Options.
5. Select  for Miscellaneous Options 3.

7.7.8.1 Alarm Verification Time

You can set the alarm verification time from 1 to 250 seconds (default is 60 seconds).

To set the alarm verification:







6. Enter the desired number of seconds for the alarm verification time.
7. Press  or  to make your selection and move to the next programming option.



7.7.8.2 Daylight Saving Time Start and End

This option lets you to adjust the week and month Daylight Saving Time (DST) starts and ends. For this feature to work, you must enable (set to *Yes*) the DST option under Misc. Options 1 (see Section 7.7.6.3). You can view and change the settings in this option anytime, however, settings will not take effect until 2007. The default values for the DST Start and End options reflect the August 8, 2005 DST law that goes into effect in 2007:

```
DST Start: The second Sunday in March
DST End: The first Sunday in November
```



To set the start and end for Daylight Saving Time:

8. Press the  or  arrow to select the week (1st, 2nd, etc.) Daylight Saving Time starts, then press  to make your selection and move to the month setting.
9. Press the  or  arrow to select the month (January – December) Daylight Saving Time starts, then press  to make your selection and move to the DST End option.



10. Press the ▲ or ▼ arrow to select the week (1st, 2nd, etc.) Daylight Saving Time ends, then press  to make your selection and move to the month setting.
11. Press the ▲ or ▼ arrow to select the month (January – December) Daylight Saving Time ends, then press  two times to make your selection and exit Misc. Options 3.

7.7.10 Edit Voice Commands

When a voice output group is selected to be activated by a zone, the cadence pattern choices listed in Section 7.4.1.4 do not apply. For voice output groups, one of six system-wide voice commands will activate instead of the cadence pattern. Which command is determined by the event type selected for that zone. This menu option allows you program, the message to be used, the tone used, repeats, and message delays, for each of the six command. Table 7-3 lists the six different commands and the associated event type. See also Section 7.4.1 for more information.

1. Press  or  to display the main menu.
2. Select  for Program Menu.
3. Enter code if prompted.

```
Display reads:      Initializing
                  Please wait . . .
```

4. Select  for System Options.
5. Select  for Edit Voice Cmds.
6. Select the command you wish to edit (1 - 6).
7. Select the desired message used for that command.
8. Select the tone to be played between messages. (High-Lo, Ansi Whoop, Cont. Whoop, ANSI, March Code, California, Steady, or Alert Tone.)
9. Select how many times you wish the message to repeat. (None, 1 - 14, or Continuous.)
10. Select the initial delay time (0 to 28 seconds, in 4 second increments).
11. Select the inter message delay time (4 to 32 seconds, in 4 second increments).
12. Enable/Disable AMR (Allow Message to Repeat with new alarm). Y = Yes, N = No.

4. Select for System Options.
5. Enter the computer account number, then press .
6. Enter the computer code (up to 7-digits), then press .
7. Enter the phone number the panel will dial to connect to a downloading computer (up to 24-digits), then press . See Table 7-7 for special dialing characters.

7.10 Access Codes

Access codes provide the user access to the control panel functions. Each access code can be customized for each user. This allows some users the ability to access programming and other higher level panel functions, while other users may only need access to lower level functions such as performing fire drills, or acknowledging trouble conditions.

Profile 1 is the profile that dictates what functions the Fire Fighter Key has access to. Because this is the profile for a key the user name and the access code can not be edited for this profile.

Profile 2 is the profile for the installer and is referred to as the "Installer Code". This profile's user name and panel functions can not be edited.

Table 7-8 lists the panel functions that can be selected for each user profile.



Table 7-8: User Profile Selectable Panel Functions

Type of Function	Selectable Functions
Panel Operations	System Reset
	System Silence
	Event Acknowledge
	Fire Drill Key

Table 7-8: User Profile Selectable Panel Functions

Type of Function	Selectable Functions
Panel Menus	System Test
	Fire Drill
	Indicator Test
	Walk Test no Report
	Walk Test with Report
	Dialer Test
	Clear History Buffer
	Point Functions
	Disable/Enable Point
	Point Status
	Set SLC Device Address
	SLC Device Locator
	SLC Multi-Device Locator
	I/O Point Control
	Event History
	Set Time & Date
	Printer Options
	Event Logging
	Print Event History
	Print Detector Status
	Print System Configuration
Reset Dialer	
Program Menu	
System Information	
Upload/Download	



To change an access code:

1. Press  or  to display the main menu.
2. Select  for Program Menu.
3. Enter code if prompted.

Display reads: Initializing
 Please wait . . .

4. Select  for System Options.

Display reads: Select Profile 01
 Fire Fighter's Key





5. Select the access code you wish to edit by pressing the  or  arrow.
6. Then press .

7.10.1 Profile Edit Menu



From the Profile Edit Menu you can change the users name, access code, and the panel functions that the user will have access to with their code.

Note: Profile 1 (Fire Fighter's Key) the user name and access code can not be edited. Profile 2 (Installer) the user name and panel functions can not be edited.



7.10.1.1 Edit Name





7. Select each character of a word by pressing the  or  arrow, then press  to move to the next character.
8. Repeat step 7 until user name is complete.
9. Then press  to finish.

7.10.1.2 Edit Access Code

10. Enter new access code (minimum of 4 digits, maximum of 7 digit)
11. Press .
12. Enter code again.
13. Press .

7.10.1.3 Panel Functions

14. Press the  or  arrow to move through the list of available functions.



15. Then press  to move to Y (yes) or N (no) selection column.
16. Press the  or  arrow to select Y or N.
17. Press .
18. Repeat steps 14 through 17 until user profile is complete.

7.11 VIP-VCM Maintenance

This programming menu option enables the user to add and edit the user message stored in the VIP-VCM. See the *VIP-Series Installation Manual* (PN 151286) for more information.

1. Press  or  to display the main menu.
2. Select  for Program Menu.
3. Enter code if prompted.

```
Display reads:           Initializing
                   Please wait . . .
```

4. Select  for System Options.
5. Select  for VIP-VCM Maint.

7.11.1 PC Connection

This option is used when adding or editing user message through the 7780 software.

6. Connect the computer to the VIP-VCM via the serial ports.
7. Run the 7780 software.
8. Select .
9. Through the 7780 software add or edit the system messages.

7.11.2 Local Recording

Select this option if you wish to record the user message with the VIP-VCM microphone, or through the sound card of your PC. See the *VIP-Series Installation Manual* (PN 151286) for more information.

10. Select .
11. Select the module you wish for play back
12. Select the circuit of the selected module you wish to hear the message played back on.

13. Record your the user message.

Section 8

System Operation

Operation of the control panel is simple. Menus guide you step-by-step through operations. This section of the manual is an overview of the operation menus. Please read this entire section carefully before operating the panel.

Press **ENTER** to view Main Menu: Select the desired menu option. Enter your access code if prompted.

Note: See Section 7.10 for information on how to modify user access code profiles.

8.1 Default User and Installer Codes

User Code: Factory-programmed as 1111.

Installer Code: Factory-programmed as 123456.

8.2 Annunciator Description

Figure 8-1 shows the annunciator that is part of the control panel board assembly.

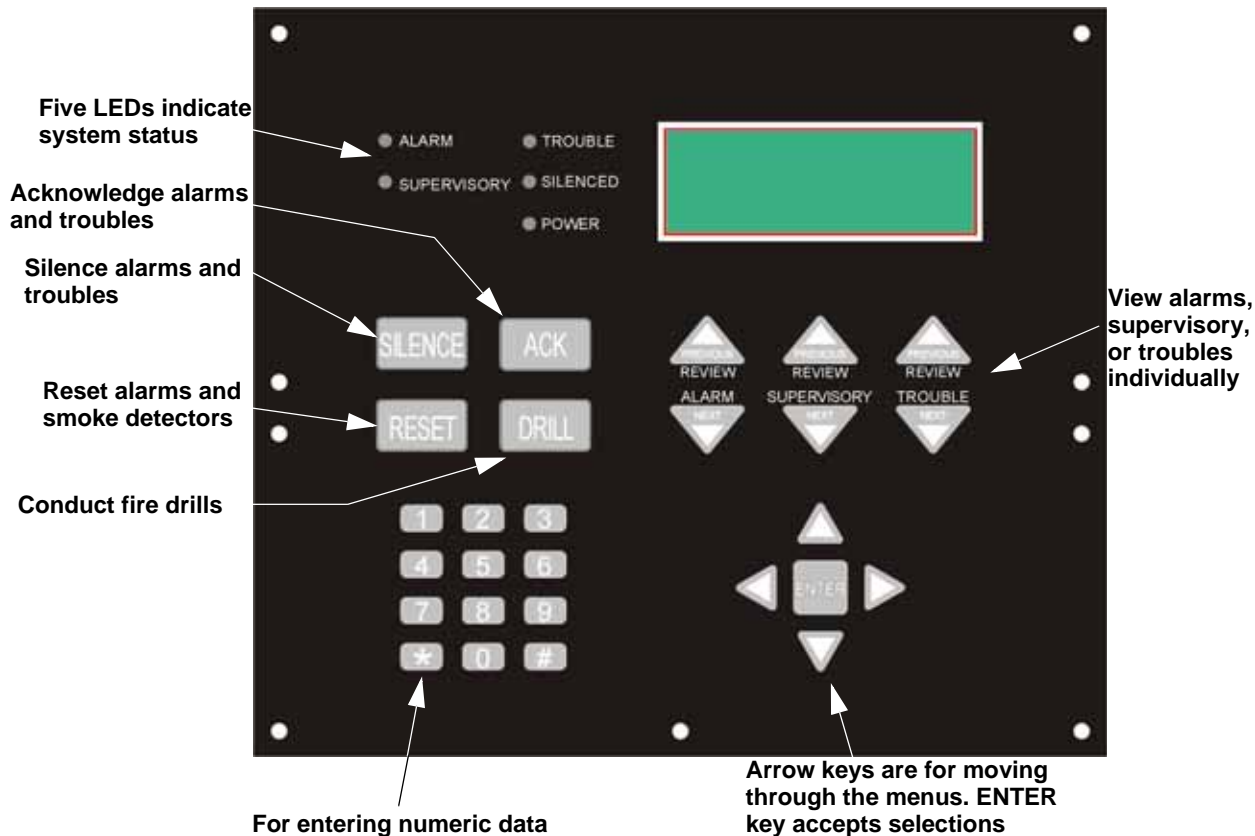

Figure 8-1 Control Panel Annunciator

8.2.1 LCD Displays

The control panel LCD displays system messages, annunciates alarms, supervisories and troubles; provides status information; and prompts for input. These messages can be up to 80 characters, displaying over four lines of 20 characters each. Annunciator keys beep when they are pressed.



8.2.2 Banner

The banner is the message that displays on the control panel when the system is in normal mode (no alarm or trouble condition exists and menus are not in use). You can create a customized message that will display instead of the internal (default) message. See Section 7.7.9 for information on customizing the banner.



Figure 8-2 Banner Display Examples

8.3 Menu System

The control panel is easy to operate from the Main Menu. To view the Main Menu press the  or  button on the control panel or remote annunciator. The Main Menu will appear as shown in Section 8.3.1. Select the desired option and enter your access code if prompted.

The control panel supports up to 20 access codes. The profile for each access code (or user) can be modified through the programming menu option (see Section 7.10 for access code programming).

8.3.1 Main Menu Overview

The chart below is a brief overview of the Main Menu. These options are described in greater detail throughout this section of the manual.

Main Menu Options	Description
1 System Tests	From here both menus can access Fire Drill and Indicator Test.
2 Point Functions	From here both menus can enable / disable points.
3 Event History	Display event history on the LCD. See Section 8.4.4 for more information.
4 Set Time and Date	Set time and date for the system.
5 Printer Options	Options for controlling a printer if attached to the system. If a printer is used, the Model 5824 serial/parallel interface module must be used.
6 Reset Dialer	Cancel any attempt to call the central station. Any calls awaiting additional attempts will be aborted.
7 Program Menu	Brings up a set of menus for programming the panel, including changing access codes. These options are described in detail in Section 7.
8 System Info	View system information, including model and serial numbers and revision number and date.
9 Up/Download	Initiate communication from the panel site between the panel and a computer running the Silent Knight Software Suite.

8.3.2 Using the Menus

To move through the menus:	Use ▼ and ▲ to move through the options in a menu. Use to move to a previous menu.
To select an option:	Enter the number of the option. -OR- Press ENTER (Enter key) if the option appears at the top of the menu (= symbol displays after the option number in this case).

8.4 Basic Operation

8.4.1 Setting Time and Date

1. From the Main Menu, select **4** for Set Date and Time.
2. Make changes in the fields on the screen. Use ► (right arrow) to move through the fields. Use the ▼ and ▲ to select options in the fields.
3. When the date and time are correct, press **ENTER**.

8.4.2 Disable / Enable a Point

1. From the Main Menu, select **2** for Point Functions.
2. Select **1** for Disable/Enable Point. A list of modules displays.
3. Use ▼ and ▲ to move through the list. Press **ENTER** to select the module where the point you want to disable/enable is located. A description of the point should display. The fourth line of the screen should show "NORMAL" (meaning that the point is currently enabled) or "DISABLED" (the point is currently disabled). Press ► to toggle between NORMAL and DISABLE.

8.4.3 Disable / Enable NACs by Group

1. From the Main Menu, select **2** for point functions.
2. Select **1** to Disable NACs by group or **2** to Enable NACs by group.
3. Use ▼ and ▲ to move through the list of groups. Press **ENTER** to select the group highlighted.

8.4.4 View Event History

Use the View Event History feature to display events on LCD. From the Main Menu, press **[3]** to select Event History. Events will begin displaying with most recent events first.

The panel can store up to 1000 events. When it reaches its 1000-event capacity, it begins deleting, starting with the oldest events.

If a printer is attached to the system (via a Module 5824 serial/parallel interface module), you can print event history (see Section 8.4.18).

The 5650/5651 SKSS can be used to retain more than 1000 events and to create event history reports.

8.4.5 Clear Event History

From the Main Menu select **[1]** for System Tests. From the test menu select **[6]** Clear History Buffer.

8.4.6 Conduct a Fire Drill

1. From the Main Menu, press **[1]** for System Tests.
2. Press **[1]** for Fire Drill. You will be prompted to press **[ENTER]**.
3. The drill will begin immediately after you press **[ENTER]**.
4. Press any key to end the drill. (If you do not press any key to end the fire drill manually, it will time out automatically after one hour.)

If a fire drill switch has been installed, activating the switch will begin the drill; deactivating the switch will end the drill.

8.4.7 Conduct an Indicator Test

The indicator test checks the annunciator LEDs, PZT, and LCD display.

1. From the Main Menu, press **[1]** for System Tests.
2. Press **[2]** for Indicator Test. The system turns on each LED several times, beeping the PZT as it does so. At the same time it scrolls each available character across the LCD. A problem is indicated if any of the following occurs:
 - An LED does not turn on;
 - You do not hear a beep;
 - All four lines of the LCD are not full.

This test takes approximately 15 seconds to complete. You can press any key to end manually while the test is still in progress. When the test ends, you will be returned to the <Test Menu>.

8.4.8 Conduct a Walk Test

1. From the Main Menu, press **[1]** for System Tests.

IMPORTANT!

If any alarm verification zones are being used, the user will be asked if they wish to disable alarm verification during walk test. This occurs for either walk test option.

2. Select **[3]** for Walk Test-No Rpt. Enter the time period you wish the NAC circuit to be active for each alarm (06 to 180 seconds). The LCD will display "WALK TEST STOPPED" on Line 1 and "ENTER = start test" on Line 2. By selecting this option, central station reporting is disabled while the test is in progress.

Or

Select **[4]** for Walk Test-with Rpt. Enter the time period you wish the NAC circuit to be active for each alarm (06 to 180 seconds). The LCD will display "WALK TEST STOPPED" on Line 1 and "ENTER = start test" on Line 2. By selecting this option, central station reporting will occur as normal during the walk test.

The panel generates a TEST report to the central station when the walk test begins. During a walk test, the panel's normal fire alarm function is completely disabled, placing the panel in a local trouble condition. All zones respond as 1-Count zones (respond when a single detector is in alarm) during a walk test. Each alarm initiated during the walk test will be reported and stored in the event history buffer.

3. Press **[ENTER]** to end the walk test. The system will reset. The panel will send a "TEST RESTORE" report to the central station.

If you do not end the walk test manually within four hours, it will end automatically. If an alarm or pre-alarm condition is occurring in the system, you will not be able to enter the walk test.

Note: the panel does not do a full 30 second reset on resettable power outputs. As soon as the device is back to normal, the panel is ready to go to the next device.

8.4.9 Conduct a Dialer Test

1. From the Main Menu, press **[1]** for System Tests.
2. Select **[5]** for Dialer Test. The screen will display "Manual dialer test started". When the test is completed, you will be returned to the <Test Menu>.

8.4.10 Silence alarms or troubles

Press **SILENCE** and enter your code. If an external silence switch has been installed, activating the switch will silence alarms or troubles.

Note: Alarm and trouble signals that have been silenced but the detector remains un-restored will un-silence every 24 hours until it is restored.

8.4.11 Reset alarms

Press **RESET** and enter your code. If an external reset switch has been installed, activating the switch will reset alarms.

8.4.12 Check Detector Through Point Status

The control panel constantly monitors smoke detectors to ensure that sensitivity levels are in compliance with NFPA 72.

If sensitivity for a detector is not in compliance, the panel goes into trouble, generating a CAL TRBLE condition. A detector enters a CAL MAINT state to indicate that it is approaching an out of compliance condition (but is currently still in compliance).

When a CAL TRBLE condition occurs, the central station receives a detector trouble report (“373” + Zone # for Contact ID format; “FT” + Zone # in SIA format).

To check sensitivity for an individual detector, follow the steps below. Section 8.4.18 provides instructions for printing the status of all detectors in the system.

1. From the Main Menu, press **2** for Point Functions.
2. Press **2** for Point Status.
3. Select the module where the point you want to check is located.
4. Enter the number of the point you want to check and press **ENTER**.

- A screen similar to those shown in Figure 8-3 will display.

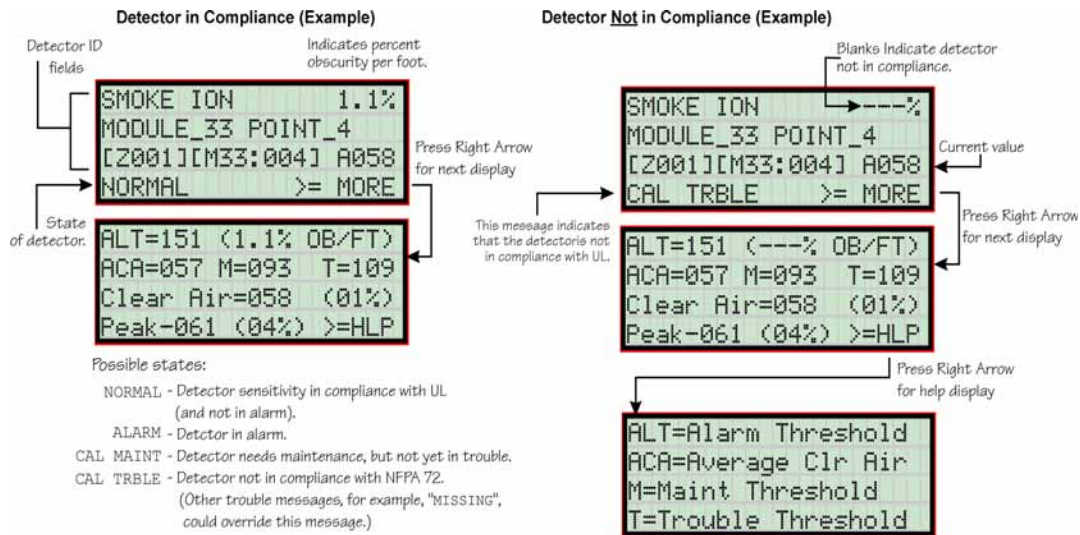

Figure 8-3 Checking Detector Sensitivity Compliance

If a printer is attached to the system (via a Module 5824 serial/parallel printer interface module), you can print detector status (see Section 8.4.18).

8.4.13 View Status of a Point

- From the Main Menu, select **2** for Point Status.
- From the list that displays, press **ENTER** to select the module where this point is located. The screen that displays will show you if the point has a trouble and will provide sensitivity compliance information. (See Section 8.4.12 for complete information about detector sensitivity compliance.)

8.4.14 View Alarms or Troubles

When the system is in alarm or trouble, you can press **▽** to view the location of an alarm or trouble. See Section 8.4.14 for more information.

8.4.15 View System Information

Press **8** from the Main Menu to view the panel model and serial number and system version number and date. The information displays for several seconds then returns to the main menu.

8.4.16 Reset dialer

From the Main Menu, select **6**. The LCD will display "Dialer reset in progress..." You will be returned to the Main Menu when the reset is completed.

8.4.17 Communicating with a Remote Computer

An installer at the panel site can initiate communications between the panel and a computer running the Silent Knight Software Suite 5650/5651. You can use this feature to upload a panel configuration. For example, if you have made programming changes to an installation on site using an annunciator, you can send your changes to the computer, so that the central station will have the latest data about the installation. See the software manual for more information (PN 151241).

To initiate communication, follow the steps below.

1. From the Main Menu, select **9** for Up/Download.
2. From the next screen that displays, select the communication device. Options are:

1 = Internal Modem	If you select this option, you will use the panel's built-in modem to call the panel.
2 = RS232 connection	If you select this option, the panel and a computer are both on-site connected via a 9-pin straight-through serial cable.
3. If you are using the panel's internal modem to communicate, you will be prompted to enter a phone number. If you are communicating via the RS232 connection, a phone number is not needed and this step will be skipped.

If the phone number you will be calling is already displayed, press **ENTER**. Continue with Step 4.

If the phone number you will be calling is not already displayed, enter the number and press **ENTER**. A phone number can be up to 24 digits long and can contain the following special characters.

#	Pound (or number) key on the telephone
*	Star key on the telephone
,	Comma (character for 2-second pause)

Use the number buttons on the annunciator or the up- and down-arrow keys to select special characters. Characters begin displaying after "9".

4. You will be prompted to enter an account number. If the account number you want to use is already displayed, just press **ENTER** to begin communication.

If the account number displayed is not the correct one, enter the account number and press **ENTER** to begin communication.
5. The panel will attempt to communicate with the computer. If communication was established, the upload task you created will be placed on the Downloading Software job queue, awaiting processing. When processing is completed, an "Unsolicited Upload" task will appear in the queue.

8.4.18 Working with a Printer

If you are using the Model 5824 serial/parallel printer interface module, several printing options are available. See Section 4.7 for information about installing the 5824.

1. From the Main Menu, select **[5]** Printer Options.
2. From the next screen, select the 5824 module where the printer is connected.
3. If the printer is not currently busy printing another report, a screen with the following options will be available. If the printer is busy, a message will display. You can press **[1]** to cancel the current print job. These options will then display.

[1] = Event Logging

Enables event logging, which causes the printer to continuously print events as they occur. The date/time will print in 24-hour military format. Once event logging is enabled, it will remain enabled until canceled by the installer. If you need to disable event logging, return to this option and press **[1]** to disable.

Sample Event Log

```

EVENT LOG:                                     STARTED: 02/17/97 02:23
02/17/97 11:23 Event: System Silenced
02/17/97 11:24 Event: System Reset
02/17/97 14:30 Event: Local Programming Begin
02/17/97 15:01 Event: Local Programming Ended Successfully

EVENT LOG:                                     STOPPED: 02/17/97 15:02
    
```

[2] = Print Event History

Prints the up-to-1000 events currently stored in the panel's event history buffer. Events print starting with the newest. The date and time printed will be when the event actually occurred and will print in 24-hour military format.

Sample Event History Print-Out

```

EVENT HISTORY:                                PRINTED: 02/28/97 13:35
02/20/97 09:02 Event 3 of 10: System Silenced
02/20/97 09:05 Event 2 of 10: System Reset
02/22/97 08:47 Event 4 of 10: Printer Off Line 4
02/22/97 08:52 Event 4 of 10: Printer On Line 4
02/25/97 15:54 Event 5 of 10: Local Programming Begin
02/25/97 16:10 Event 5 of 10: Local Programming Ended Successfully
02/28/97 12:50 Event 6 of 10: Walk Test Begin
02/28/97 13:31 Event 2 of 10: Walk Test End
:
:
    
```

[3] = Print Detector Status

Prints the current status of all detectors in the system. This is a method for finding out if any detectors are out of NFPA compliance or any detectors need maintenance (are approaching an out of compliance condition).

Sample Detector Status Print-Out

```

DETECTOR STATUS:                             PRINTED: 06/09/98 13:45
NFPA72 Compliant
Peak Percent Alarm
Peak Clear Air
Current Percent Alarm
Clear Air Value
Trouble Threshold
Maintenance Threshold
Average Clear Air
Alarm Threshold Level
Sensitivity %/ft or deg F
Zone Number

ID NAME      TYPE  ZN  SENS  ATL  ACA  MT  TT  CAV  %A  PCA  %A  STATUS
-----
Module 33
063 MODULE_33 POINT_3  PHOTO 1 --- 240 141 83 94 140 0 141 0 CAL TRBL N
065 MODULE_33 POINT_65  HEAT  1 150 150 0 N/A N/A 73 48 73 48 NORMAL Y
066 MODULE_33 POINT_66  HEAT  1 150 150 0 N/A N/A 73 48 73 48 NORMAL Y
067 MODULE_33 POINT_67  HEAT  1 150 150 0 N/A N/A 73 48 73 48 NORMAL Y
068 MODULE_33 POINT_68  HEAT  1 150 150 0 N/A N/A 73 48 73 48 NORMAL Y
    
```

Note: Detector status can also be viewed and printed using the 5650/5651 or 5670 SKSS (facility monitoring only).

8.5 Operation Mode Behavior

The control panel can be in one of seven conditions at any given moment: Normal, Alarm, Prealarm, Supervisory, Trouble, Silenced, and Reset. Table 10-1 describes the behavior of the panel in each of these modes.

Table 8-1: Operation Mode Behavior

Operation Mode	Occurs When	System Behavior	In This Mode You Can
Normal	No alarm or trouble condition exists and menus are not in use.	<p>SYSTEM POWER LED is on.</p> <p>The All Systems Normal display indicates that the system is in normal mode.</p>  <p>The current date and time display on the last line of the LCD.</p>	<p>Press ENTER to display main menu options. Select the desired option and enter access code.</p>
Alarm	A smoke detector goes into alarm or a pull station is activated.	<p>The dialer seizes control of the phone line and calls the central station.</p> <p>The on-board annunciator sounds a loud, steady beep (any notification devices attached to the system will also sound).</p> <p>GENERAL ALARM LED flashes.</p> <p>The LCD displays a screen similar to this one.</p> <p>Count of alarms in the system In this example there are 5.</p>  <p>Press the down arrow to view the type and location of alarm. (Message alternates with the date/time display.)</p>	<p>Press the down arrow to view the alarm. A screen similar to this one displays.</p>  <p>Module and Point name Device type</p> <p>Zone name</p> <p>Shows which event is currently being displayed. In this example, there are 5 alarms, the third is being displayed.</p> <p>Press SILENCE and enter an access code (if prompted) to silence the annunciator (and any notification devices attached to the system).</p> <p>When the alarm condition clears, press RESET and enter a code to restore the panel to normal.</p>

Table 8-1: Operation Mode Behavior

Operation Mode	Occurs When	System Behavior	In This Mode You Can
<p>Prealarm</p>	<p>A single detector trips in a 2-Count zone. (2-Count means two detectors must trip before an alarm is reported.)</p>	<p>Touchpad PZT beeps. The LCD displays a screen similar to this one.</p> <p style="text-align: center;">Count of alarms in the system In this example there is 1.</p> <div style="border: 2px solid black; padding: 5px; width: fit-content; margin: 10px auto;"> <p>PREALARM cnt[1]</p> <p>Press ↓ for status</p> </div> <p>Press the down arrow to view the type and location of prealarm. (Message alternates with the date/time display.)</p>	<p>Press ▼ (down arrow) to view the prealarm. A screen similar to this one displays.</p> <p>Module and Point name Device type</p> <div style="border: 2px solid black; padding: 5px; width: fit-content; margin: 10px auto;"> <p>PREALARM: SMOKE- PHOTO</p> <p>MODULE_33 POINT_2</p> <p>ZONE_2</p> <p style="text-align: right;">1 of 1</p> </div> <p>Zone name Shows which event is currently being displayed.</p> <p>All system operations are available in this mode.</p>
<p>Reset</p>	<p>The RESET button is pressed followed by a valid code.</p>	<p>All LEDs are on briefly then the LCD displays "ALARM RESET IN PROGRESS". If the reset process completes normally, the date and time normal mode screen displays.</p>	<p>Menus are not available during the reset process.</p>
<p>Silenced</p>	<p>An alarm or trouble condition has been silenced but still exists. To silence alarms and troubles, press SILENCE followed by an access code if prompted.</p>	<p>SYSTEM SILENCE LED is on. SYSTEM TROUBLE, SUPERVISORY or GENERAL ALARM LED (depending on condition) is on. The annunciator (and any notification devices attached to the system) will be silenced.</p>	<p>Press ▼ (down arrow) to view the location of the alarm or trouble. When the condition no longer exists, the SYSTEM SILENCED and SYSTEM TROUBLE LED, SUPERVISORY or GENERAL ALARM LEDs turn off.</p>

8.6 Releasing Operations

This control panel supports two types of releasing: Double Interlock Zone and Single Interlock Zone. The Double Interlock Zone operation requires an interlock switch input in the system, and the Single Interlock does not. An interlock switch is typically a dry-contact pressure switch.

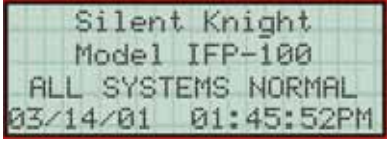
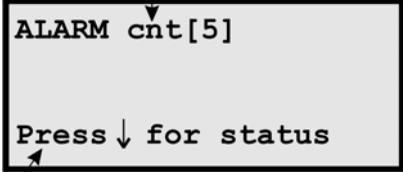
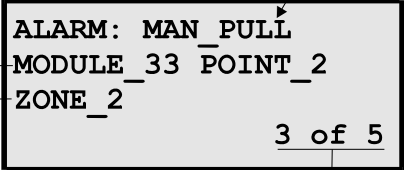
When a Single or Double Interlock Zone releasing is selected the system will automatically default the following system parameters:

Note: The defaults created can be modified through programming if desired.

- Output Group 2 is created. Output Group 2 will be defaulted as an "Alarm" output group for all releasing zones. NAC [34:001] is assigned to Output Group 2.
- Output Group 3 is created. Output Group 3 will be defaulted as an "Pre-Alert" output group for all releasing zones. NAC [34:002] is assigned to Output Group 3.
- Output Group 4 is created. Output Group 4 will be defaulted as a "Release" output group for all releasing zones. NAC circuit [34:003] is assigned to Output Group 4.

Note: The installer must define which input points will be used for detectors, manual release switches, or interlock/pressure switches.

Table 8-2: Approved Releasing Solenoids

Manufacturer	Part Number	Rating
Asco	T8210A107	24 VDC, 3A
	8210G207	24 VDC, 3A

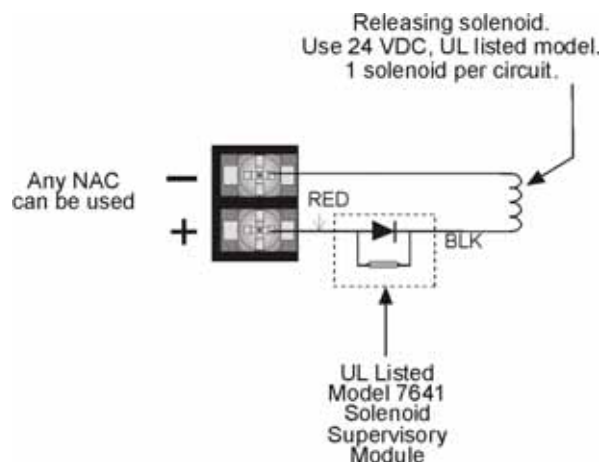

Figure 8-4 Wiring Configuration for Solenoid

Important!

Detectors must be installed at 0.7 times the linear spacing as described in NFPA 72, Chapter 2.

8.6.1 Single Interlock Zone Releasing

A single interlock zone utilizes a minimum of two addressable detectors, and a designated manual release switch.

Important!
Only addressable detectors can be used. No conventional detectors can be used.
Each Single Interlock Zone input requires at least one manual release switch.

Conditions Required for an Pre-Alert Output Activation

If any single addressable detector is activated, the "Pre-Alert" output will activate. This alerts the user that the initial stages required for a release condition are present. (Also refer to Table 8-3.)

Conditions required for an General Alarm and Release Output Activation

If two or more addressable detectors, or a manual release switch activate, the "Alarm" and the "Release" outputs will activate. (Also refer to Table 8-3.)

Table 8-3: Single Interlock Zone Operation

Inputs	Output Results							
1st Addressable Detector		✓		✓		✓		✓
2nd Addressable Detector			✓	✓			✓	✓
Manual Release Station					✓	✓	✓	✓
	Normal	Pre-Alert	Pre-Alert	Release and General Alarm	Release and General Alarm	Release and General Alarm	Release and General Alarm	Release and General Alarm

Reduce detector spacing to 0.7 times the linear spacing in accordance with NFPA 72.

Note: Refer to Table 8-2 for approved releasing solenoids and ratings.

8.6.2 Double Interlock Zone Releasing

A Double Interlock Zone uses a minimum of two Addressable detectors, a designated manual release switch, and an interlock switch input. An interlock switch is typically a dry-contact pressure switch and will be referred to as an interlock/pressure switch in this document.

Important!
Only addressable detectors can be used. No conventional detectors can be used.
Each Single Interlock Zone input requires at least one manual release switch.
Each Double Interlock Zone input requires at least one Interlock/pressure switch

Conditions Required for a Pre-Alert Output Activation

If any single addressable detector is activated, the "Pre-Alert" output will activate. This alerts the user that the initial stages required for a release condition are present. (Also refer to Table 8-3.)

Conditions Required for a General Alarm Output Activation

If two addressable detectors, a manual release switch is activated, or an interlock switch is active, the "Pre-Alert", and "General Alarm" outputs will activate.

Conditions Required for a Release Output Activation

Any release requires the activation of an interlock switch, and either a manual release switch or 2 activated addressable detectors. When these conditions are met, the "Release" and "General Alarm" outputs will activate, and the "Alert" outputs will deactivate.

Table 8-4: Double Interlock Zone Operation

Inputs	Output Results															
	Normal	Pre-Alert	Pre-Alert	Pre-Alert and General Alarm	Pre-Alert and General Alarm	Pre-Alert and General Alarm	Pre-Alert and General Alarm	Pre-Alert and General Alarm	Pre-Alert and General Alarm	Pre-Alert and General Alarm	Pre-Alert and General Alarm	Release and General Alarm	Release and General Alarm	Release and General Alarm	Release and General Alarm	Release and General Alarm
1st Addressable Detector		✓		✓		✓		✓		✓		✓		✓		✓
2nd Addressable Detector			✓	✓			✓	✓			✓	✓			✓	✓
Manual Release Station					✓	✓	✓	✓					✓	✓	✓	✓
Interlock/Pressure Switch									✓	✓	✓	✓	✓	✓	✓	✓

Reduce detector spacing to 0.7 times the linear spacing in accordance with NFPA 72.

Note: Refer to Table 8-2 for approved releasing solenoids and ratings.

8.7 Smoke Alarm Verification

Figure 8-5 illustrates how the Smoke Alarm Verification cycle operates.

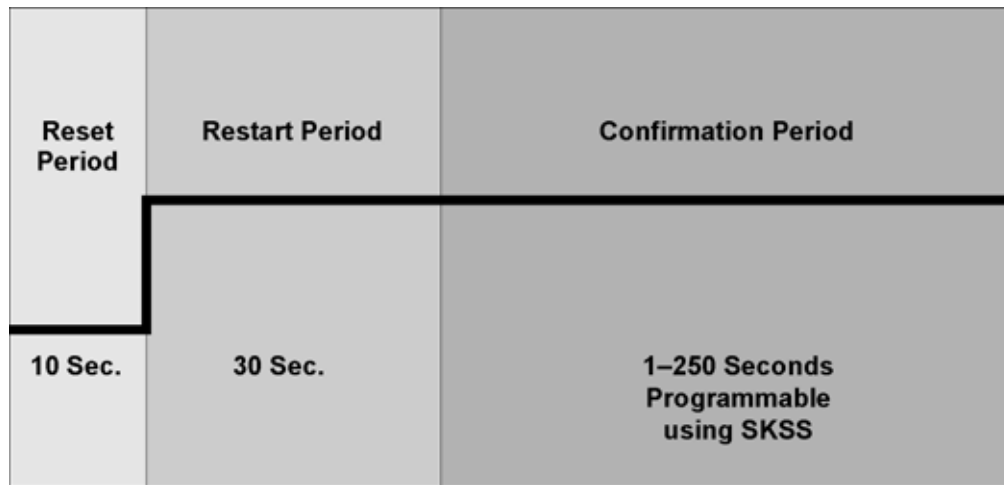

Figure 8-5 Smoke Verification Cycle

During the Confirmation Period if there is no alarm indication then the system will return to normal operation.

Section 9

Reporting

This section lists receivers that are compatible with this control panel, and the reporting codes sent by the control panel for SIA and Contact ID formats.

9.1 Receivers Compatible with the Control Panel

Table 9-1 shows receivers compatible with the control panel.

Table 9-1: Receivers Compatible with the Control Panel

Manufacturer	Model	Format
Silent Knight	Model 9800	SIA and Contact ID
	Model 9000 (SIA formats)	SIA
Ademco	Model 685 (Contact ID)	Contact ID
Sur-Gard	SG-MLR2-DG (V. 1.64 or higher)	SIA and Contact ID
Osborne Hoffman	Quickalert	SIA and Contact ID

9.2 Reporting Formats Dialer Outputs

Event Description	Event Family	Event Class (System, Zone, or Point)	SIA Reporting Format			Contact ID Reporting Format			
			Module ID # (if any)	SIA Event Code	Parameter (if any)	Qualifier	Event Code	Group #	Contact #
System Events	Note: System events are reported when either "Report by Point" or "Report by Zone" is selected.								
AC power restore	Trouble	System Event		AR		3	301	00	000
AC power lost	Trouble	System Event		AT		1	301	00	000
SBUS expander trouble restore	Trouble	System Event		ER	Exp. ID	3	333	00	Exp. ID
SBUS Class A supervision restore	Trouble	System Event		ER	Exp. ID	3	333	00	Exp. ID
Short circuit removed from SLC communication loop	Trouble	System Event		ER	Exp. ID	3	332	00	Exp. ID
SLC Class A supervision restored	Trouble	System Event		ER	Exp. ID	3	331	00	Exp. ID
SBUS expander trouble	Trouble	System Event		ET	Exp. ID	1	333	00	Exp. ID
SBUS Class A supervision lost	Trouble	System Event		ET	Exp. ID	1	333	00	Exp. ID
Short circuit detected on SLC communication loop	Trouble	System Event		ET	Exp. ID	1	332	00	Exp. ID
SLC Class A supervision lost	Trouble	System Event		ET	Exp. ID	1	331	00	Exp. ID
Fire drill has begun	Test	System Event		FI		1	604	00	000
Fire drill ended	Test	System Event		FK		3	604	00	000
Panel date has been changed	Trouble	System Event		JD		1	625	00	000
Panel time has been changed	Trouble	System Event		JT		1	625	00	000
Local programming begin	Trouble	System Event		LB		1	627	00	000
Phone line 1 trouble restore	Trouble	System Event		LR	1	3	351	00	001
Phone line 2 trouble restore	Trouble	System Event		LR	2	3	352	00	002
Local programming ended normally	Trouble	System Event		LS		1	628	00	000
VIP – DMR Trouble	Trouble	System Event		ET	Exp. ID	3	332	Exp. ID	000
VIP – DMR Trouble Restore	Trouble	System Event		ER	Exp. ID	1	332	Exp. ID	000
Phone line 1 trouble detected	Trouble	System Event		LT	1	1	351	00	001

Event Description	Event Family	Event Class (System, Zone, or Point)	SIA Reporting Format			Contact ID Reporting Format			
			Module ID # (if any)	SIA Event Code	Parameter (if any)	Qualifier	Event Code	Group #	Contact #
Phone line 2 trouble detected	Trouble	System Event		LT	2	1	352	00	002
Local programming aborted or ended with errors	Trouble	System Event		LU		1	628	00	000
Periodic test event – normal	Test	System Event		RP		1	602	00	000
Periodic test event – off normal	Test	System Event		RY		1	608	00	000
Initial power up	Trouble	System Event		RR		1	305	00	000
Remote programming ended normally	Trouble	System Event		RS		1	412	00	000
Unable to report to an account	Trouble	System Event		RT	Acct #	1	354	Acct #	Acct #
Remote programming aborted or ended with errors	Trouble	System Event		RU		1	413	00	000
User has initiated dialer test	Test	System Event		RX		1	601	00	
Water release circuit has been disabled	Trouble	System Event	pi Exp. ID	SS	Pnt #	1	203	Exp. ID	Pnt #
Water release circuit has been re-enabled	Trouble	System Event	pi Exp. ID	SR	Pnt #	3	203	Exp. ID	Pnt #
Walk test end	Test	System Event		TE		3	607	00	000
SLC address programming ended; system has been re-enabled.	Test	System Event		TE		3	607	00	000
Walk test begin	Test	System Event		TS		1	607	00	000
SLC address programming started; system has been shut down.	Test	System Event		TS		1	607	00	000
Printer paper restore	Trouble	System Event		VI	Exp ID	3	335	00	Exp. ID
Printer is out of paper	Trouble	System Event		VO	Exp ID	1	335	00	Exp. ID
Printer back online	Trouble	System Event		VY	Exp ID	3	336	00	Exp. ID
Printer offline	Trouble	System Event		VZ	Exp ID	1	336	00	Exp. ID
Auto dialer test communication trouble	Trouble	System Event		YC	Line #	1	350	00	Line #
Report to an account successful	Trouble	System Event		YK	Acct #	3	354	Acct #	Acct #
Auto dialer test communication trouble restore	Trouble	System Event		YK	Line #	3	350	00	Line #
Ground fault condition detected	Trouble	System Event		YP	Exp. ID	1	310	00	Exp. ID
Ground fault condition restore	Trouble	System Event		YQ	Exp. ID	3	310	00	Exp. ID
Battery voltage restore	Trouble	System Event		YR	Exp. ID	3	302	00	Exp. ID
Battery voltage low	Trouble	System Event		YT	Exp. ID	1	302	00	Exp. ID
Zone Events	Note: Zone events are reported only when "Report by Zone" is selected.								
SLC LED Module trouble restore	Trouble	Zone Event		ER	0000	3	333	00	000
SLC LED Module trouble	Trouble	Zone Event		ET	0000	1	333	00	000
Manual pull switch alarm	Alarm	Zone Event		FA	Zone	1	115	00	Zone
Detector alarm	Alarm	Zone Event		FA	Zone	1	110	00	Zone
Manual pull switch alarm restore	Restore	Zone Event		FH	Zone	3	115	00	Zone
Detector alarm restore	Restore	Zone Event		FH	Zone	3	110	00	Zone
Manual pull switch trouble restore	Trouble	Zone Event		FJ	Zone	3	373	00	Zone
Detector trouble restore	Trouble	Zone Event		FJ	Zone	3	373	00	Zone
Positive Alarm Sequence acknowledge switch trouble restore	Trouble	Zone Event		FJ	Zone	3	373	00	Zone
Auxiliary power trouble restore	Trouble	Zone Event		FJ	0000	3	320	00	000
Notification output trouble restore	Trouble	Zone Event		FJ	1000+Group #	3	320	00	Group #
Manual pull switch trouble	Trouble	Zone Event		FT	Zone	1	373	00	Zone
Detector trouble	Trouble	Zone Event		FT	Zone	1	373	00	Zone
Positive Alarm Sequence acknowledge switch trouble	Trouble	Zone Event		FT	Zone	1	373	00	Zone
Auxiliary power trouble	Trouble	Zone Event		FT	0000	1	320	00	000
Notification trouble	Trouble	Zone Event		FT	1000+Group #	1	320	00	Group #
User initiated a system reset	Reset	Zone Event		OR		1	401	00	000
Water flow switch alarm	Alarm	Zone Event		SA	Zone	1	113	00	Zone
Water flow switch alarm restore	Restore	Zone Event		SH	Zone	3	113	00	Zone
Water flow switch trouble restore	Trouble	Zone Event		SJ	Zone	3	373	00	Zone

Event Description	Event Family	Event Class (System, Zone, or Point)	SIA Reporting Format			Contact ID Reporting Format			
			Module ID # (if any)	SIA Event Code	Parameter (if any)	Qualifier	Event Code	Group #	Contact #
Supervisory/Tamper switch trouble restore	Trouble	Zone Event		SJ	Zone	3	373	00	Zone
Supervisory condition restore	Trouble	Zone Event		SR	Zone	3	203	00	Zone
Supervisory condition	Trouble	Zone Event		SS	Zone	1	203	00	Zone
Water flow switch trouble	Trouble	Zone Event		ST	Zone	1	373	00	Zone
Supervisory/Tamper switch trouble	Trouble	Zone Event		ST	Zone	1	373	00	Zone
Zone-based AUX1 switch alarm	Alarm	Zone Event		UA	1000+Zone	1	140	01	Zone
Zone-based AUX2 switch alarm	Alarm	Zone Event		UA	2000+Zone	1	140	02	Zone
System-based AUX1 switch alarm	Alarm	Zone Event		UA	1000	1	140	01	000
System-based AUX2 switch alarm	Alarm	Zone Event		UA	2000	1	140	02	000
Zone-based AUX1 switch alarm restore	Restore	Zone Event		UH	1000+Zone	3	140	01	Zone
Zone-based AUX2 switch alarm restore	Restore	Zone Event		UH	2000+Zone	3	140	02	Zone
System-based AUX1 switch alarm restore	Restore	Zone Event		UH	1000	3	140	01	000
System-based AUX2 switch alarm restore	Restore	Zone Event		UH	2000	3	140	02	000
Zone-based AUX1 switch trouble restore	Trouble	Zone Event		UJ	1000+Zone	3	373	01	Zone
Zone-based AUX2 switch trouble restore	Trouble	Zone Event		UJ	2000+Zone	3	373	02	Zone
System-based AUX1 switch trouble restore	Trouble	Zone Event		UJ	1000	3	373	01	000
System-based AUX2 switch trouble restore	Trouble	Zone Event		UJ	2000	3	373	02	000
External Reset/Silence/Fire Drill switch trouble restore	Trouble	Zone Event		UJ	0000	3	373	00	000
Zone-based AUX1 switch trouble	Trouble	Zone Event		UT	1000+Zone	1	373	01	Zone
Zone-based AUX2 switch trouble	Trouble	Zone Event		UT	2000+Zone	1	373	02	Zone
System-based AUX1 switch trouble	Trouble	Zone Event		UT	1000	1	373	01	000
System-based AUX2 switch trouble	Trouble	Zone Event		UT	2000	1	373	02	000
External Reset/Silence/Fire Drill switch trouble	Trouble	Zone Event		UT	0000	1	373	00	000
Point Events	Note: Point events are reported only when "Report by Point" is selected. When IDP protocol devices are used, sensors 1–99 are reported as Pnt #s 1–99, and modules 1–99 are reported as Pnt #s 201–299.								
Manual pull switch alarm	Alarm	Point Event	pi Exp. ID	FA	Pnt #	1	115	Exp. ID	Pnt #
Manual release switch alarm (Water Release Zone)	Alarm	Point Event	pi Exp. ID	FA	Pnt #	1	110	Exp. ID	Pnt #
Interlock switch alarm (Water Release Zone)	Alarm	Point Event	pi Exp. ID	FA	Pnt #	1	110	Exp. ID	Pnt #
Detector alarm	Alarm	Point Event	pi Exp. ID	FA	Pnt #	1	110	Exp. ID	Pnt #
Point disabled	Disable	Point Event	pi Exp. ID	FB	Pnt #	1	571	Exp. ID	Pnt #
Manual pull switch alarm restore	Restore	Point Event	pi Exp. ID	FH	Pnt #	3	115	Exp. ID	Pnt #
Manual release switch alarm restore (Water Release Zone)	Restore	Point Event	pi Exp. ID	FH	Pnt #	3	110	Exp. ID	Pnt #
Interlock switch alarm restore (Water Release Zone)	Restore	Point Event	pi Exp. ID	FH	Pnt #	3	110	Exp. ID	Pnt #
Detector alarm restore	Restore	Point Event	pi Exp. ID	FH	Pnt #	3	110	Exp. ID	Pnt #
Notification output trouble restore	Trouble	Point Event	pi Exp. ID	FJ	Pnt #	3	320	Exp. ID	Pnt #
Manual pull switch trouble restore	Trouble	Point Event	pi Exp. ID	FJ	Pnt #	3	373	Exp. ID	Pnt #
Manual release switch trouble restore (Water Release Zone)	Trouble	Point Event	pi Exp. ID	FJ	Pnt #	3	373	Exp. ID	Pnt #
Interlock switch trouble restore (Water Release Zone)	Trouble	Point Event	pi Exp. ID	FJ	Pnt #	3	373	Exp. ID	Pnt #
Detector trouble restore	Trouble	Point Event	pi Exp. ID	FJ	Pnt #	3	373	Exp. ID	Pnt #
Positive Alarm Sequence acknowledge switch trouble restore	Trouble	Point Event	pi Exp. ID	FJ	Pnt #	3	373	Exp. ID	Pnt #
Aux power trouble restore	Trouble	Point Event	pi Exp. ID	FJ	Pnt #	3	320	Exp. ID	Pnt #
Notification output trouble	Trouble	Point Event	pi Exp. ID	FT	Pnt #	1	320	Exp. ID	Pnt #
Manual pull switch trouble	Trouble	Point Event	pi Exp. ID	FT	Pnt #	1	373	Exp. ID	Pnt #
Manual release switch trouble (Water Release Zone)	Trouble	Point Event	pi Exp. ID	FT	Pnt #	1	373	Exp. ID	Pnt #
Interlock switch trouble (Water Release Zone)	Trouble	Point Event	pi Exp. ID	FT	Pnt #	1	373	Exp. ID	Pnt #
Detector trouble	Trouble	Point Event	pi Exp. ID	FT	Pnt #	1	373	Exp. ID	Pnt #
Positive Alarm Sequence acknowledge switch trouble	Trouble	Point Event	pi Exp. ID	FT	Pnt #	1	373	Exp. ID	Pnt #
Auxiliary Power Trouble	Trouble	Point Event	pi Exp. ID	FT	Pnt #	1	320	Exp. ID	Pnt #

Event Description	Event Family	Event Class (System, Zone, or Point)	SIA Reporting Format			Contact ID Reporting Format			
			Module ID # (if any)	SIA Event Code	Parameter (if any)	Qualifier	Event Code	Group #	Contact #
Point Enabled	Disable	Point Event	pi Exp. ID	FU	Pnt #	3	571	Exp. ID	Pnt #
Water flow switch alarm	Alarm	Point Event	pi Exp. ID	SA	Pnt #	1	113	Exp. ID	Pnt #
Water flow switch disabled	Disable	Point Event	pi Exp. ID	SB	Pnt #	1	571	Exp. ID	Pnt #
Supervisory/Tamper switch or supervisory duct detector disabled	Disable	Point Event	pi Exp. ID	SB	Pnt #	1	571	Exp. ID	Pnt #
Water flow switch alarm restore	Restore	Point Event	pi Exp. ID	SH	Pnt #	3	113	Exp. ID	Pnt #
Water flow switch trouble restore	Trouble	Point Event	pi Exp. ID	SJ	Pnt #	3	373	Exp. ID	Pnt #
Supervisory/Tamper switch or supervisory duct detector trouble restore	Trouble	Point Event	pi Exp. ID	SJ	Pnt #	3	373	Exp. ID	Pnt #
Supervisory condition restore	Trouble	Point Event	pi Exp. ID	SR	Pnt #	3	203	Exp. ID	Pnt #
Supervisory condition	Trouble	Point Event	pi Exp. ID	SS	Pnt #	1	203	Exp. ID	Pnt #
Water flow switch trouble	Trouble	Point Event	pi Exp. ID	ST	Pnt #	1	373	Exp. ID	Pnt #
Supervisory/Tamper switch or supervisory duct detector trouble	Trouble	Point Event	pi Exp. ID	ST	Pnt #	1	373	Exp. ID	Pnt #
Water flow switch re-enabled	Disable	Point Event	pi Exp. ID	SU	Pnt #	3	571	Exp. ID	Pnt #
Supervisory/Tamper switch or supervisory duct detector re-enabled	Disable	Point Event	pi Exp. ID	SU	Pnt #	3	571	Exp. ID	Pnt #
Zone-based AUX1 switch alarm	Alarm	Point Event	pi Exp. ID	UA	Pnt #	1	140	Exp. ID	Pnt #
Zone-based AUX2 switch alarm	Alarm	Point Event	pi Exp. ID	UA	Pnt #	1	140	Exp. ID	Pnt #
System-based AUX1 switch alarm	Alarm	Point Event	pi Exp. ID	UA	Pnt #	1	140	Exp. ID	Pnt #
System-based AUX2 switch alarm	Alarm	Point Event	pi Exp. ID	UA	Pnt #	1	140	Exp. ID	Pnt #
Auxiliary switch input disabled	Disable	Point Event	pi Exp. ID	UB	Pnt #	1	571	Exp. ID	Pnt #
Zone-based AUX1 switch alarm restore	Restore	Point Event	pi Exp. ID	UH	Pnt #	3	140	Exp. ID	Pnt #
Zone-based AUX2 switch alarm restore	Restore	Point Event	pi Exp. ID	UH	Pnt #	3	140	Exp. ID	Pnt #
System-based AUX1 switch alarm restore	Restore	Point Event	pi Exp. ID	UH	Pnt #	3	140	Exp. ID	Pnt #
System-based AUX2 switch alarm restore	Restore	Point Event	pi Exp. ID	UH	Pnt #	3	140	Exp. ID	Pnt #
Zone-based AUX1 switch trouble restore	Trouble	Point Event	pi Exp. ID	UJ	Pnt #	3	373	Exp. ID	Pnt #
Zone-based AUX2 switch trouble restore	Trouble	Point Event	pi Exp. ID	UJ	Pnt #	3	373	Exp. ID	Pnt #
External Reset/Silence/Fire Drill switch trouble restore	Trouble	Point Event	pi Exp. ID	UJ	Pnt #	3	373	Exp. ID	Pnt #
System-based AUX1 switch trouble restore	Trouble	Point Event	pi Exp. ID	UJ	Pnt #	3	373	Exp. ID	Pnt #
System-based AUX2 switch trouble restore	Trouble	Point Event	pi Exp. ID	UJ	Pnt #	3	373	Exp. ID	Pnt #
Zone-based AUX1 switch trouble	Trouble	Point Event	pi Exp. ID	UT	Pnt #	1	373	Exp. ID	Pnt #
Zone-based AUX2 switch trouble	Trouble	Point Event	pi Exp. ID	UT	Pnt #	1	373	Exp. ID	Pnt #
External Reset/Silence/Fire Drill switch trouble	Trouble	Point Event	pi Exp. ID	UT	Pnt #	1	373	Exp. ID	Pnt #
System-based AUX1 switch trouble	Trouble	Point Event	pi Exp. ID	UT	Pnt #	1	373	Exp. ID	Pnt #
System-based AUX2 switch trouble	Trouble	Point Event	pi Exp. ID	UT	Pnt #	1	373	Exp. ID	Pnt #
Auxiliary switch input re-enabled	Disable	Point Event	pi Exp. ID	UU	Pnt #	3	571	Exp. ID	Pnt #
An unexpected SLC device has been detected	Trouble	Point Event	pi Exp. ID	XE	Pnt #	1	380	Exp. ID	Pnt #
An unexpected SLC device has been removed	Trouble	Point Event	pi Exp. ID	XI	Pnt #	3	380	Exp. ID	Pnt #

Section 10

Testing and Troubleshooting

10.1 Troubleshooting

This section of the manual offers suggestions for troubleshooting hardware problems. Please read this section if you encounter a problem when installing the control panel. If these suggestions do not solve your problem or if you encounter a problem that is not listed here, contact Silent Knight Technical Support at 800-328-0103 for assistance.

10.2 Common Problems

Problem	Possible Cause / Suggested Actions
Trouble message "DBL ADDR" (Double Address) displays on LCD.	An address has been assigned to more than one detector. Correct the address following the procedure described in Section 5.8 for Hochiki devices and Section 5.6 for IDP devices.
Auxiliary power or notification circuits have incorrect polarity.	Correct polarity. For notification and auxiliary power circuits: When in alarm or powered, terminals labeled "X" are positive, terminals labeled "O" are negative.
SLC devices are not being recognized (trouble message "Missing" displays).	Check hardware connections. If devices are physically connected, make sure wiring is correct (see Section 5.4 for Hochiki devices and Section 5.5 for IDP devices). For the main panel, the positive side of device must be connected to terminal 34; the negative side must be connected to Terminal 33. For SLC devices, make sure the device connects to the SLC loop via the SLC OUT terminals.
	Make sure SLC devices have been addressed properly following the procedure described in Section 5.8 for Hochiki devices and Section 5.6 for IDP devices. For contact monitor modules, which are addressed using dipswitches, the dipswitch must be set to the correct address before power is applied to the SLC loop. If this procedure is not followed, the device will have an incorrect address.
	Make sure correct polarity has been observed for SLC device wiring. See Section 5.8 for Hochiki devices and Section 5.5 for IDP devices.

Problem	Possible Cause / Suggested Actions
SLC devices are not being recognized (trouble message "Missing" displays on the annunciator).	<p>Check that SLC loop impedance is within the required range. To measure impedance, use the following procedure.</p> <ol style="list-style-type: none"> 1. Disconnect both wires from the terminal block at the panel (SLC devices can remain connected). 2. Measure the impedance from positive to negative and from negative to positive. Both measurements should be greater than 500 K ohms. If the installation uses T-taps, test each T-tap individually. 3. Temporarily connect the positive wire to the negative wire of the SLC loop at the point farthest from the panel (SLC devices can remain connected). 4. Measure the impedance from positive to negative and from negative to positive. Both measurements must be less than 50 ohms.
The panel indicates a ground fault trouble condition (trouble message "GROUND FAULT" displays).	<p>An earth ground fault occurs when the panel senses an unexpected flow of current from one or more of its terminals to the earth connection (Terminal 2). Isolate the wiring that is causing the fault by removing wiring connections one at a time until the earth fault is no longer present. Pause at least five seconds after removing a wire before removing the next one.</p> <p>The panel will also go into ground fault if a computer is connected to the panel via a serial cable attached to the panel's 9-pin connector. This is a correct method for on-site communication between a panel and a computer. Ignore the ground fault message in this case. The trouble will clear automatically when you disconnect the computer from the cable</p>
5496 module that has been physically connected to the panel but is not being recognized.	<p>Check the status of the 5496 green LED. If it flashes in the pattern .5 sec on / .5 sec. off, it is likely that the 5496 has not been added to the system through programming. JumpStart will add any 5496s connected to the panel. If you have already run JumpStart, 5496s can be added manually (see Section 7.3.2).</p> <p>Check that the correct ID for the 5496 module has been set through the dipswitches. Assign ID#1 to the first 5496 and ID#2 to the second 5496. See Section 4.10 for complete details.</p> <p>If the wiring between the 5496 and the panel is correct, measure the voltage from 5496 Terminal (+) to Terminal (-). Voltage should be in the range 27.2-27.4V when AC power is present.</p> <p>If the green LED is not flashing, the likely cause is incorrect wiring from between the 5496 and the panel. See Section 4.4 for wiring details.</p>

10.2.1 Event History

The event history can be useful for tracking or recalling a trouble condition.

10.3 Built-in Troubleshooting and Testing Tools

The fire control panel has several built-in testing and troubleshooting tools that can be utilized to save time while testing and troubleshooting points and SLC devices.

10.3.1 SLC Device Locator

SLC device locator can be used to locate a device on a SLC loop.

Follow these steps to locate a particular SLC device:

1. Select (Point Functions) from the Main Menu.
2. Select (SLC Dev Locator).

A message similar to the one shown in Figure 10-1 will display.

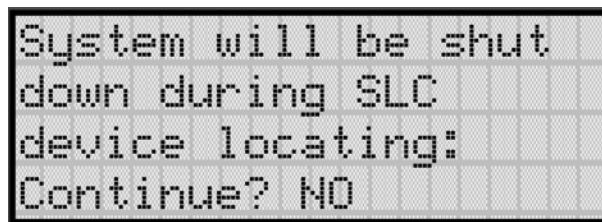

Figure 10-1 Shut Down Warning

3. Press the or arrow to toggle NO to YES then press .

If NO is chosen you will exit back to the Point Function menu.

If YES is chosen the system will cease normal operation leaving the premise unprotected.

4. Select the SLC loop.
5. Enter the SLC address of the device you wish to locate.

The LED on the selected device will start flashing.

6. Press any key to exit SLC device locator function.

Note: Once you exit the system will resume normal operation.

10.3.2 SLC Multi Locator

This feature is the same as SLC Device Locator, except you can locate up to 8 devices on a single search.

Follow these instructions to locate multiple SLC devices:

1. Select (Point Functions) from the Main Menu.
2. Select (SLC Dev Locator).

A message similar to the one shown in Figure 10-1 will display.

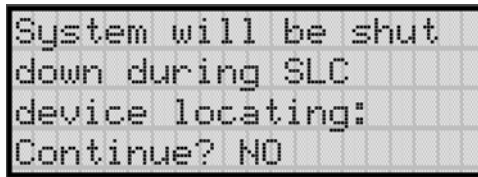

```
System will be shut
down during SLC
device locating:
Continue? NO
```

Figure 10-2 Shut Down Warning

3. Press the or arrow to toggle NO to YES then press .

If NO is chosen you will exit back to the Point Function menu.

If YES is chosen the system will cease normal operation leaving the premise unprotected.

4. Select the SLC loop.
5. Enter up to 8 SLC addresses for the devices you wish to locate.

The LEDs on the selected devices will start flashing.

6. Press the to exit SLC multi-locator function.

Note: Once you exit the system will resume normal operation.

10.3.3 I/O Point Control

This feature allows you to toggle any output on or off and trip any input device. This can be useful to test a point's output mapping.

Follow these steps to control a I/O point:

1. Select **2** (Point Functions) from the Main Menu.
2. Select **6** (I/O Point Control).
3. Select the Module the point is on.
4. Enter the zone number, or press the **▲** or **▼** arrow to select the point you wish to test, then press **ENTER**.
5. Press **ENTER** to generate an alarm for an input point or activate an output point.
6. To exit press **◀**.

10.4 Impedances that Cause Earth Ground Faults

Table 10-1 show the minimum impedances that cause an earth ground fault on this system.

Table 10-1: Earth Ground Faults in Ohms

TERMINAL (values in kohms)	LOW BIASED		HIGH BIASED	
	high trip	high restore	low trip	low restore
NAC 1 -	0	0		
NAC 1 +			0	0
NAC 2 -	0	0		
NAC 2 +			0	0
NAC 3 -	0	0		
NAC 3 +			0	0
NAC 4 -	0	0		
NAC 4 +			0	0
SBUS -			0	0
SBUS +	0	0		
SBUS A			0	0
SBUS B			0	0
SLC IN -			0	0
SLC IN +	0	0		
SLC OUT -			0	0
SLC OUT +	0	0		

Section 11

Installation Records

This section of the manual is for you to use if you wish to track of how points, zones, and groups have been programmed.

11.1 Hochiki SLC Device Point Record

You can use Table 11-1 to keep track of Hochiki SLC device points.
 Default addresses for ID:On-board: = 33

Table 11-1: Hochiki Installation Record

Module	Addr	Zone / Group	Description	Module	Addr	Zone/ Group	Description
On-board	1			On-board	28		
On-board	2			On-board	29		
On-board	3			On-board	30		
On-board	4			On-board	31		
On-board	5			On-board	32		
On-board	6			On-board	33		
On-board	7			On-board	34		
On-board	8			On-board	35		
On-board	9			On-board	36		
On-board	10			On-board	37		
On-board	11			On-board	38		
On-board	12			On-board	39		
On-board	13			On-board	40		
On-board	14			On-board	41		
On-board	15			On-board	42		
On-board	16			On-board	43		
On-board	17			On-board	44		
On-board	18			On-board	45		
On-board	19			On-board	46		
On-board	20			On-board	47		
On-board	21			On-board	48		
On-board	22			On-board	49		
On-board	23			On-board	50		
On-board	24			On-board	51		
On-board	25			On-board	52		
On-board	26			On-board	53		
On-board	27			On-board	54		

Table 11-1: Hochiki Installation Record

Module	Addr	Zone / Group	Description	Module	Addr	Zone/ Group	Description
On-board	55			On-board	92		
On-board	56			On-board	93		
On-board	57			On-board	94		
On-board	58			On-board	95		
On-board	59			On-board	96		
On-board	60			On-board	97		
On-board	61			On-board	98		
On-board	62			On-board	99		
On-board	63			On-board	100		
On-board	64			On-board	101		
On-board	65			On-board	102		
On-board	66			On-board	103		
On-board	67			On-board	104		
On-board	68			On-board	105		
On-board	69			On-board	106		
On-board	70			On-board	107		
On-board	71			On-board	108		
On-board	72			On-board	109		
On-board	73			On-board	110		
On-board	74			On-board	111		
On-board	75			On-board	112		
On-board	76			On-board	113		
On-board	77			On-board	114		
On-board	78			On-board	115		
On-board	79			On-board	116		
On-board	80			On-board	117		
On-board	81			On-board	118		
On-board	82			On-board	119		
On-board	83			On-board	120		
On-board	84			On-board	121		
On-board	85			On-board	122		
On-board	86			On-board	123		
On-board	87			On-board	124		
On-board	88			On-board	125		
On-board	89			On-board	126		
On-board	90			On-board	127		
On-board	91						

Appendix A

Compatible Devices

Table A-1: Compatible Notification Appliances

Manufacturer	Model	Audio	Visual	Type
AMSECO	SH24W-153075	✓	✓	Horn/Strobe
	SAD24-153075		✓	Strobe
	SAD24-75110		✓	Strobe
	SL24W-75110		✓	Strobe
	SL24C-3075110		✓	Strobe
	SLB24-75		✓	Strobe
	RSD24-153075		✓	Strobe
	RSD24-75110		✓	Strobe
	SH24W-75110	✓	✓	Horn/Strobe
	SH24W-3075110	✓	✓	Horn/Strobe
	SHB24-75	✓	✓	Horn/Strobe
	SCM24W-153075	✓		Chimes/Strobe
	SCM24W-75110	✓		Chimes/Strobe
	SCM24C-3075110	✓		Chimes/Strobe
	SCM24C-177	✓		Chimes/Strobe
	H24W	✓		Horn
	H24R	✓		Horn

Table A-1: Compatible Notification Appliances

Manufacturer	Model	Audio	Visual	Type
Faraday	446			Vibrating Bell
	476			Vibrating Bell
	477			Single Stroke Bell
	2700 -M, -R, -T, -Y, -Z			Strobe
	2701 Series			Strobe
	2705 Series			Strobe
	2820	✓	✓	Sync Temporal Horn/Strobe
	2821	✓	✓	Sync Temporal Horn/Strobe
	2824	✓	✓	Horn Strobe
	5333			Multi-Tone Horn)
	5336			Multi-Tone Horn/Strobe
	5337			Multi-Tone Horn/Strobe
	5338			Multi-Tone Horn/Strobe
	5343			Single Tone Horn/Strobe
	5346			Electronic Horn with Strobe
	5347			Electronic Horn with Strobe
	5348			Single Tone Horn/Strobe
	5373			8-Tone Horn/Strobe
	6321			Sync Mini Horn/Strobe
	6322			Mini Horn/Sync Strobe
	6380			8-Tone Electronic Signal/Strobe
	5376			8-Tone Horn/Strobe
	5377			8-Tone Horn/Strobe
	5378			8-Tone Horn/Strobe
	5383			8-Tone Horn/Strobe with Sync Strobe
	5386			8-Tone Horn/Strobe with Sync Strobe
5387			8-Tone Horn/Strobe with Sync Strobe	

Table A-1: Compatible Notification Appliances

Manufacturer	Model	Audio	Visual	Type
Faraday	5388			8-Tone Horn/Strobe with Sync Strobe
	5508			Single Gang Sync Strobe
	5509			Strobe
	5510			Strobe
	5511			Strobe
	5512			Strobe
	5516			Strobe
	5517			Strobe
	5518			Strobe
	5519			Strobe
	5521			4" Square Sync Strobe
	5522			4" Square Sync Strobe
	6120			Horn
	6140			Horn
	6223			Horn
	6226			Horn/Strobe
	6227			Horn/Strobe
	6228			Horn/Strobe
	6243			Electron-Mechanical Horn
	6244			Electron-Mechanical Horn
	6245			Electron-Mechanical Horn
	6246			Electron-Mechanical Horn/Strobe
	6247			Electron-Mechanical Horn/Strobe
	6248			Electron-Mechanical Horn/Strobe
	6300			Mini-Horn
	6301			Mini-Horn
	6302			Mini-Horn
	6310			Mini-Horn/Strobe
	6311			Mini-Horn/Strobe
	6312			Mini-Horn/Strobe
	6314 Series -M, -R, -T, -Y, -Z			Strobe
	6320			Sync Mini Horn/Strobe

Table A-1: Compatible Notification Appliances

Manufacturer	Model	Audio	Visual	Type
FCI	S2415-FC			Strobe
	S241575-FC			Strobe
	S2430-FC			Strobe
	130-3117C			Mini Horn
	130-3147C			Mini Horn
	BLV-6			Vibrating Bell
	BLV-10			Vibrating Bell
	BLVCH			Vibrating Chime
	H12/24-FC			Horn
	H12/24W-FC			Horn
	H12/24K-FC			Horn
	HC12/24-FC			Horn
	HC12/24W-FC			Horn
	HC12/24K-FC			Horn
	P2415-FC			Horn/Strobe
	P2415W-FC			Horn/Strobe
	P2415K-FC			Horn/Strobe
	P241575-FC			Horn/Strobe
	P241575W-FC			Horn/Strobe
	P241575F-FC			Horn/Strobe
	P241575K-FC			Horn/Strobe
	P2430-FC			Horn/Strobe
	P2430W-FC			Horn/Strobe
	P2430K-FC			Horn/Strobe
	P2475-FC			Horn/Strobe
	P2475W-FC			Horn/Strobe
	P2475K-FC			Horn/Strobe
	P24110-FC			Horn/Strobe
	P24110W-FC			Horn/Strobe
	P24110K-FC			Horn/Strobe
	S2430W-FC			Strobe
	S2430K-FC			Strobe
	S2475-FC			Strobe
FCI	S2475W-FC			Strobe
	S2475K-FC			Strobe
	S24110-FC			Strobe
	S24110W-FC			Strobe
	S24110K-FC			Strobe
Federal Signal	450			Horn
	VALS			Horn/Strobe

Table A-1: Compatible Notification Appliances

Manufacturer	Model	Audio	Visual	Type	
Gentex	GEC-24-15	✓	✓	Horn/Strobes	
	GEC-24-30	✓	✓	Horn/Strobes	
	GEC-24-60	✓	✓	Horn/Strobes	
	GEC-24-75	✓	✓	Horn/Strobes	
	GEC-24-177	✓	✓	Horn/Strobes	
	GX91	✓		MiniHorn Steady Tone	
	GX93	✓		MiniHorn Temporal Tone	
	HG124			Horn	
	HS24-15	✓	✓	Horn/Strobe	
	HS24-30	✓	✓	Horn/Strobe	
	HS24-60	✓	✓	Horn/Strobe	
	HS24-75	✓	✓	Horn/Strobe	
	HS24-110	✓	✓	Horn/Strobe	
	HS24-1575	✓	✓	Horn/Strobe	
	GCC24	✓	✓	Multi Candella Horn/Strobe Ceiling Mount	
	GCCR24	✓	✓	Multi Candella Horn/Strobe Ceiling Mount	
	GCS24		✓	Multi Candella Strobe Ceiling Mount	
	GCSR24		✓	Multi Candella Strobe Ceiling Mount	
	GEGR-24	✓	✓	Multi Candella Horn/Strobe	
	GES24-15			✓	Strobes
	GES24-30			✓	Strobes
	GES24-60			✓	Strobes
	GES24-75			✓	Strobes
	GES24-110			✓	Strobes
	GES24-15/75			✓	Strobes
	GES24-177			✓	Strobes
	GES3-24			✓	Multi Candella Strobe
	GESR-24			✓	Multi Candella Strobe
	GEH-24	✓			Horn
	ST24-30			✓	Strobe

Table A-1: Compatible Notification Appliances

Manufacturer	Model	Audio	Visual	Type
Gentex con't	ST24-60		✓	Strobe
	ST24-75		✓	Strobe
	ST24-110		✓	Strobe
	ST24-1575		✓	Strobe
	WGEC24-75W	✓	✓	Weatherproof Horn/Strobe
	WGES24-75W		✓	Weatherproof Strobe
	WGMS-24-X			Horn/Strobe
	SSPKWR	✓		Speaker
	SSPKWW	✓		Speaker
	SSPK-15WR	✓	✓	Speaker/Strobe
	SSPK-15WW	✓	✓	Speaker/Strobe
	SSPK-15/75WR	✓	✓	Speaker/Strobe
	SSPK-15/75WW	✓	✓	Speaker/Strobe
	SSPK-30WR	✓	✓	Speaker/Strobe
	SSPK-30WW	✓	✓	Speaker/Strobe
	SSPK-60WR	✓	✓	Speaker/Strobe
	SSPK-60WW	✓	✓	Speaker/Strobe
	SSPK-75WR	✓	✓	Speaker/Strobe
	SSPK-75WW	✓	✓	Speaker/Strobe
	SSPK-110WR	✓	✓	Speaker/Strobe
	SSPK-110WW	✓	✓	Speaker/Strobe
	SSPKCLPR	✓		Speaker
	SSPKCLPW	✓		Speaker
	SSPK24CLPR	✓	✓	Speaker/Strobe
	SSPK24CLPW	✓	✓	Speaker/Strobe
	GEC-24-110	✓	✓	Horn/Strobes
	GEC-24-15/75	✓	✓	Horn/Strobes

Table A-1: Compatible Notification Appliances

Manufacturer	Model	Audio	Visual	Type
System Sensor	CHR	✓		Chime
	CHW	✓		Chime
	CHSR	✓	✓	2-Wire Chime/Strobe
	CHSW	✓	✓	2-Wire Chime/Strobe
	HR	✓	✓	Horn
	HW		✓	Horn
	HRK		✓	Horn
	P2R	✓	✓	2-Wire Horn/Strobe
	P2R-P	✓	✓	2-Wire Horn/Strobe
	PC2R	✓	✓	2-Wire Horn/Strobe
	PC2R-P	✓	✓	2-Wire Horn/Strobe
	P2RH	✓	✓	2-Wire Horn/Strobe High Candela
	P2RH-P	✓	✓	2-Wire Horn/Strobe High Candela
	PC2RH	✓	✓	2-Wire Horn/Strobe High Candela
	PC2RH-P	✓	✓	2-Wire Horn/Strobe High Candela
	P2W	✓	✓	2-Wire Horn/Strobe
	P2W-P	✓	✓	2-Wire Horn/Strobe
	PC2W	✓	✓	2-Wire Horn/Strobe
	PC2W-P	✓	✓	2-Wire Horn/Strobe
	P2WH	✓	✓	2-Wire Horn/Strobe High Candela
	P2WH-P	✓	✓	2-Wire Horn/Strobe High Candela
	PC2WH	✓	✓	2-Wire Horn/Strobe High Candela
	PC2WH-P	✓	✓	2-Wire Horn/Strobe High Candela
	P2RK	✓	✓	2-Wire Horn/Strobe
	PC2RK	✓	✓	2-Wire Horn/Strobe
	P2RHK	✓	✓	2-Wire Horn/Strobe High Candela
	PC2RHK	✓	✓	2-Wire Horn/Strobe High Candela
	P4R	✓	✓	4-Wire Horn/Strobe
	PC4R	✓	✓	4-Wire Horn/Strobe
	P4RH	✓	✓	4-Wire Horn/Strobe High Candela

Table A-1: Compatible Notification Appliances

Manufacturer	Model	Audio	Visual	Type	
System Sensor (cont.)	P4W	✓	✓	4-Wire Horn/Strobe	
	PC4W	✓	✓	4-Wire Horn/Strobe	
	P4WH	✓	✓	4-Wire Horn/Strobe High Candela	
	PC4WH	✓	✓	4-Wire Horn/Strobe High Candela	
	P4RK	✓	✓	4-Wire Horn/Strobe	
	PC4RK	✓	✓	4-Wire Horn/Strobe	
	P4RHK	✓	✓	4-Wire Horn/Strobe High Candela	
	PC4RHK	✓	✓	4-Wire Horn/Strobe High Candela	
	PC4RH	✓	✓	4-Wire Horn/Strobe High Candela	
	SR			✓	Strobe
	SR-P			✓	Strobe
	SCR			✓	Strobe
	SCR-P			✓	Strobe
	SRH			✓	Strobe High Candela
	SRH-P			✓	Strobe High Candela
	SCRH			✓	Strobe High Candela
	SCRH-P			✓	Strobe High Candela
	SW			✓	Strobe
	SW-P			✓	Strobe
	SCW			✓	Strobe
	SCW-P			✓	Strobe
	SWH			✓	Strobe High Candela
	SWH-P			✓	Strobe High Candela
	SCWH			✓	Strobe High Candela
	SCWH-P			✓	Strobe High Candela
	SRK			✓	Strobe
	SCRK			✓	Strobe
	SRHK			✓	Strobe High Candela
	SCRHK			✓	Strobe High Candela

Table A-1: Compatible Notification Appliances

Manufacturer	Model	Audio	Visual	Type
Wheelock	AH-12	✓		Horn
	AH-24	✓		Horn
	AH-12WP	✓		Horn Weatherproof
	AH-24WP	✓		Horn Weatherproof
	AMT-241575W	✓	✓	Multi-Tone Horn Strobe
	AMT-24MCW		✓	Mutli-Tone Horn Strobe
	AMT-241575W-NYC	✓	✓	Multi-Tone Horn Strobe
	AMT-12/24	✓		Multi-tone Horn
	AMT-12/24 NYC	✓		Multi-tone Horn
	AS-121575W		✓	Horn/Strobe
	NH-12/24	✓		Horn
	AS-241575W	✓	✓	Horn/Strobe
	AS-24MCC	✓	✓	Horn/Strobe
	AS-24MCCH	✓	✓	Horn/Strobe
	AS-24MCW	✓	✓	Horn/Strobe
	AS-24MCWH	✓	✓	Horn/Strobe

Table A-1: Compatible Notification Appliances

Manufacturer	Model	Audio	Visual	Type
Wheelock (cont.)	ASWP-2475W	✓	✓	Horn/Strobe Weatherproof
	ASWP-2475C	✓	✓	Horn/Strobe Weatherproof
	ASWP-24MCWH	✓	✓	Horn/Strobe
	ASWP-24MCCH	✓	✓	Hor/Stroben
	CH70-241575W		✓	Chime/Strobe
	CH70-24MCW		✓	Chime/Strobe
	CH70-24MCWH		✓	Chime/Strobe
	CH90-24MCC		✓	Chime/Strobe
	CH90-24MCCH		✓	Chime/Strobe
	HS-24	✓		Horn
	HS4-241575W	✓	✓	Horn/Strobe
	HS4-24MCW	✓	✓	Horn/Strobe
	HS4-24MCWH	✓	✓	Horn/Strobe
	HS4-24MCC	✓	✓	Horn/Strobe
	MIZ-24S	✓	✓	Mini Horn Strobe
	MT-121575W		✓	MultitoneHorn Strobe
	MT-241575W	✓	✓	Multitone Horn Strobe
	MT-24MCW		✓	Multitone Horn Strobe
	MTWP-2475W		✓	Multitone Horn Strobe
	MTWP-2475C		✓	Multitone Horn Strobe
	MTG-121575W	✓	✓	Multitone Horn Strobe
	MTR-121575W	✓	✓	Multitone Horn Strobe
	MTWPA-2475W	✓	✓	Multitone Horn Strobe
	MTWPB-2475W	✓	✓	Multitone Horn Strobe
	MTWPG-2475W	✓	✓	Multitone Horn Strobe
	MTWPR-2475W	✓	✓	Multitone Horn Strobe
	MTWPA-24MCCH	✓	✓	Multitone Horn Strobe
	ZNH	✓		Horn
	NS-121575W	✓	✓	Horn/Strobe
	NS-241575W	✓	✓	Horn/Strobe
	NS-24MCW	✓	✓	Horn/Strobe
	NS-24MCC	✓	✓	Horn/Strobe

Table A-1: Compatible Notification Appliances

Manufacturer	Model	Audio	Visual	Type
Wheelock Con't	NS-24MCCH	✓	✓	Horn/Strobe
	ZNS-MCW	✓	✓	Horn/Strobe
	ZNS-MCWH	✓	✓	Horn/Strobe
	ZNS-24MCC	✓	✓	Horn/Strobe
	ZNS-24MCCH	✓	✓	Horn/Strobe
	RSS-121575W		✓	Strobe
	RSS-241575W		✓	Strobe
	RSS-24MCC		✓	Strobe
	RSS-24MCCR		✓	Strobe
	RSS-24MCCH		✓	Strobe
	RSS-24MCCHR		✓	Strobe
	RSS-24MCW		✓	Strobe
	RSS-24MCWH		✓	Strobe
	RSSP-121575W		✓	Strobe
	RSSP-241575W		✓	Strobe
	RSSR-2415W		✓	Strobe
	RSSR-2415C		✓	Strobe
	RSSR-2475W		✓	Strobe
	RSSR-2475C		✓	Strobe
	RSSR-24110C		✓	Strobe
	RSSA-24110W		✓	Strobe
	RSSB-24110W		✓	Strobe
	RSSG-24110W		✓	Strobe
	RSSR-24110W		✓	Strobe
	RSSA-24MCC		✓	Multi-Cd Strobe
	RSSB-24MCC		✓	Multi-Cd Strobe
	RSSG-24MCC		✓	Multi-Cd Strobe
	RSSR-24MCC		✓	Multi-Cd Strobe

Table A-1: Compatible Notification Appliances

Manufacturer	Model	Audio	Visual	Type
Wheelock Con't	RSSWPA-2475W		✓	Strobe Weatherproof
	RSSWPA-24MCCH		✓	Strobe Weatherproof
	RSSWPG-24MCCH		✓	Strobe Weatherproof
	RSSWPR-24MCCH		✓	Strobe Weatherproof
	RSSWP-2475W		✓	Strobe Weatherproof
	RSSWP-2475C		✓	Strobe Weatherproof
	RSSWP-24MCWH		✓	Strobe Weatherproof
	ZRS-MCWH		✓	Strobe
	ZRS-24MCC		✓	Strobe
	ZRS-24MCCH		✓	Strobe
	CH-70	✓		Chime
	CH-90	✓		Chime
	ET70WP-2475W	✓	✓	Speaker/Strobe
	ET70WP-2475C	✓	✓	Speaker/Strobe
	ET70WP-24185W	✓	✓	Speaker/Strobe
	ET70WP-24177C	✓	✓	Speaker/Strobe
	ET70WPA-2475	✓	✓	Speaker/Strobe
	E50	✓		Speaker
	E50-24MCW	✓	✓	Speaker/Strobe
	E50-24MCWH	✓	✓	Speaker/Strobe
	E50-241575W	✓	✓	Speaker/Strobe

Table A-1: Compatible Notification Appliances

Manufacturer	Model	Audio	Visual	Type
Wheelock con't	E60	✓		Speaker
	E60-24MCW	✓	✓	Speaker/Strobe
	E60-24MCHW	✓	✓	Speaker/Strobe
	E60-24MCC	✓	✓	Speaker/Strobe
	E60-24MCCH	✓	✓	Speaker/Strobe
	E70	✓		Speaker
	E70-MCW	✓	✓	Speaker/Strobe
	E70-24MCWH	✓	✓	Speaker/Strobe
	E70-24MCC	✓	✓	Speaker/Strobe
	E70-24MCCH	✓	✓	Speaker/Strobe
	E70-241575W	✓	✓	Speaker/Strobe
	MB-G6-24			Motor Bell
	MB-G10-24			Motor Bell
	MB-G6-12			Motor Bell
	MB-G10-12			Motor Bell
	MIZ-24-R			Mini-Horn
	MT-12/24-R	✓	✓	Multitone Horn
	MT4-12/24	✓	✓	Multitone Horn
	E70-241575W	✓	✓	Speaker/Strobe
	E90	✓		Speaker
	E90-24MCW	✓	✓	Speaker/Strobe
	E90-24MCWH	✓	✓	Speaker/Strobe
	E90-24MCC	✓	✓	Speaker/Strobe

Table A-1: Compatible Notification Appliances

Manufacturer	Model	Audio	Visual	Type
Wheelock (con't)	ET80-24MCW	✓	✓	Speaker/Strobe
	ET80-24MCWH	✓	✓	Speaker/Strobe
	ET80-241575W	✓	✓	Speaker/Strobe
	ET90	✓		Speaker
	ET90-24MCW	✓	✓	Speaker/Strobe
	ET90-24MCCH	✓	✓	Speaker/Strobe
	ET90-24MCC	✓	✓	Speaker/Strobe
	ET90-24MCWH	✓	✓	Speaker/Strobe
	ET70WP-2475W	✓	✓	Speaker/Strobe / weatherproof
	ET70WP-2475C	✓	✓	Speaker/Strobe / weatherproof
	ET70WP-24115C	✓	✓	Speaker/Strobe / weatherproof
	ET70WP-24135C	✓	✓	Speaker/Strobe / weatherproof
	ET70WP-24177C	✓	✓	Speaker/Strobe / weathertproof
	ET70WP-24185W	✓	✓	Speaker/Strobe / weatherproof
	S8-24MCC			Speaker//Strobe
	ZRS-MCW		✓	Strobe
	MTWPR-24MCCH	✓	✓	Multitone Horn Strobe
	NH-12/24R	✓		Horn

A.1 Two-Wire Smoke Detectors

Table A-2 lists two-wire smoke detectors that are compatible with the fire control panel. The table is organized by manufacturer. The columns show the number of detectors per loop that can be used.

	IFP-100
Identifier	24H
Operating Voltage Range	18.5–27.4 VDC

Note: The maximum number of smoke detectors per zone is determined by both the current draw and the impedance of the smoke detector. If too many smoke detectors are used on any zone, false alarms could occur.

Do not mix different models of detectors on any zone; false alarms could occur.

Do not mix detectors of different models unless the system is specifically intended to be installed in that configuration.

Control unit Smoke Reset Time must be programmed for a number greater than or equal to the maximum

reset time of the smoke detector.

Table A-2: Compatible Two-Wire Smoke Detectors

Manufacturer	Model Name or Number (Base model name or number in parentheses.)	Compatibility ID		# per Loop
		Head	Base	
Apollo	55000-350 (45681-200)	55000-350	45681-200	24 / loop
	55000-250 (45681-200)	55000-250	45681-200	24 / loop
ESL	429C (S10A)	N/A	S10A	30 / loop
	429CRT (S11A)	N/A	S11A	30 / loop
	429CST (S11A)	N/A	S11A	30 / loop
	429CT (S10A)	N/A	S10A	30 / loop
	609U01-11	S10	S00	40 / loop
	609U02-11	S10	S00/S03	40 / loop
	611U (601U or 602U)	S10	S00/S03	40 / loop
	611UD (601U or 602U)	S10	S00/S03	40 / loop
	611UT (601U or 602U)	S10	S00/S03	40 / loop
	612U (601U or 602U)	S10	S00/S03	40 / loop
	612UD (601U or 602U)	S10	S00/S03	40 / loop
	711U (701E or 701U)	N/A	S10A	25 / loop
	712U (701E or 701U)	N/A	S10A	25 / loop
	713-5U (702E or 701U)	N/A	S10A	25 / loop
	713-6U (702E or 701U)	N/A	S10A	25 / loop
	721-U (S10A)	N/A	S10A	30 / loop
721-UT (S10A)	N/A	S10A	30 / loop	
Falcon	525	FDT1	N/A	17 / loop
	525T	FDT1	N/A	17 / loop
Hochiki	SIH-24F (HS-224D OR HSD-224)	HD-3	HB-5	25 / loop
	SLK-24F (HS-224D)	HD-3	HB-5	25 / loop
	SLK-24FH (HS-224D)	HD-3	HB-5	25 / loop

Table A-2: Compatible Two-Wire Smoke Detectors

Manufacturer	Model Name or Number (Base model name or number in parentheses.)	Compatibility ID		# per Loop
		Head	Base	
System Sensor	1400	A	N/A	20 / loop
	1451 (B401B)	A	A	20 / loop
	2100	A	N/A	20 / loop
	2100T	A	N/A	20 / loop
	2151 (B401)	A	N/A	16 / loop
	2151T (B401)	A	N/A	16 / loop
	2300T	A	N/A	20 / loop
	2300	A	N/A	20 / loop
	2300TB	A	N/A	20 / loop
	2400	A	N/A	20 / loop
	2400 (DH400)	A	N/A	20 / loop
	2400AIT	A	N/A	20 / loop
	2400AT	A	N/A	20 / loop
	2400TH	A	N/A	20 / loop
	2451 (B401B)	A	N/A	20 / loop
	2451DH (DH 400)	A	N/A	20 / loop
	2451TH (B401B)	A	N/A	20 / loop

Appendix B

Special Characters Lists

This section contains tables of programmable characters that may be used for device, module, and zone names or phone numbers.

B.1 Characters used for Naming

Table B-1 list the available character and their associated numeric designator. When programming these numbers can be entered as a short cut to using the up or down arrow keys, to select characters when naming a point or zone.

Table B-1: Character Table

000	A	001	B	002	C	003	D
004	E	005	F	006	G	007	H
008	I	009	J	010	K	011	L
012	M	013	N	014	O	015	P
016	Q	017	R	018	S	019	T
020	U	021	V	022	W	023	X
024	Y	025	Z	026	a	027	b
028	c	029	d	030	e	031	f
032	g	033	h	034	i	035	j
036	k	037	l	038	m	039	n
040	o	041	p	042	q	043	r
044	s	045	t	046	u	047	v
048	w	049	x	050	y	051	z
052		053	0	054	1	055	2
056	3	057	4	058	5	059	6
060	7	061	8	062	9	063	:
064	-	065	_	066	.	067	,
068	&	069	*	070	#		

Silent Knight Fire Product Warranty and Return Policy

General Terms and Conditions

- All new fire products manufactured by Silent Knight have a limited warranty period of 18 months from the date of manufacture against defects in materials and workmanship. See limited warranty statement for details.
- This limited warranty does not apply to those products that are damaged due to misuse, abuse, negligence, exposure to adverse environmental conditions, or have been modified in any manner whatsoever.

Repair and RA Procedure

- All products that are returned to Silent Knight for credit or repair require a RA (Return Authorization) number. Call Silent Knight Customer Service at 800-446-6444 or 763-493-6435 between 8:00 A.M. and 4:45 P.M. CST, Monday through Friday to obtain a return authorization number. Silent Knight Technical Support is available at 800-328-0103 or 763-493-6455 between 8:00 A.M. and 5:00 P.M. CST, Monday through Friday.
- All returns for credit are subject to inspection and testing at the factory before actual determination is made to allow credit.
- RA number must be prominently displayed on the outside of the shipping box. See return address example under Advanced Replacement Policy.
- Include a packing slip that has the RA number, a content list, and a detailed description of the problem should be included with each return.
- All products returned to Silent Knight must be sent freight pre-paid. After product is processed, Silent Knight will pay for shipping product back to customer via UPS ground.
- Return the Silent Knight product circuit board only. Products that are returned in cabinets will be charged an additional \$50 to cover the extra shipping and handling costs over board only returns. **Do not return batteries.** Silent Knight has the authority to determine if a product is repairable. Products that are deemed un-repairable will be returned to the customer.
- Product that is returned that has a board date code more than 18 months from date of manufacture will be repaired and the customer will be assessed the standard Silent Knight repair charge for that model.

Advanced Replacement Policy

- Silent Knight offers an option of advance replacement for fire product printed circuit boards that fail during the first 6 months of the warranty period. These items must be returned with transportation charges prepaid and must be accompanied by a return authorization.
- For advance replacement of a defective board contact your local Silent Knight Distributor or call Silent Knight at 800-446-6444 or 763-493-6435 to obtain a RA (Return Authorization) number and request advanced replacement,

- A new or refurbished board will be shipped to the customer. The customer will initially be billed for the replacement board but a credit will be issued after the repairable board is received at Silent Knight. All returned products must comply with the guidelines described under “General Terms and Conditions”.
- The defective board must be returned within 30 days of shipment of replacement board for customer to receive credit. No credit will be issued if the returned board was damaged due to misuse or abuse.
- Repairs and returns should be sent to:
Silent Knight / Honeywell
Attn: Repair Department
7550 Meridian Circle N., Suite 100
Maple Grove, MN 55369-4927
RA Number: _____

Limited Warranty

SILENT KNIGHT warrants products manufactured by it to be free from defects in materials and workmanship for eighteen (18) months from the date of manufacture, under normal use and service. Products are date stamped at time of manufacture. The sole and exclusive obligation of SILENT KNIGHT is to repair or replace, at its option, free of charge for parts and labor, any part that is defective in materials or workmanship under normal use and service. **All returns for credit are subject to inspection and testing at the factory before actual determination is made to allow credit.** SILENT KNIGHT does not warrant products not manufactured by it, but assigns to the purchaser any warranty extended by the manufacturer of such products. This warranty is void if the product is altered or repaired by anyone other than SILENT KNIGHT or as expressly authorized by SILENT KNIGHT in writing, or is serviced by anyone other than SILENT KNIGHT or its authorized distributors. This warranty is also void if there is a failure to maintain the products and systems in which they operate in a proper and workable manner. In case of defect, secure a Return Material Authorization form from our Return Authorization Department.

This writing constitutes the only warranty made by SILENT KNIGHT, with respect to its products. SILENT KNIGHT, does not represent that its products will prevent any loss by fire or otherwise, or that its products will in all cases provide the protection for which they are installed or intended. Buyer acknowledges that SILENT KNIGHT is not an insurer and assumes no risk for loss or damages or the cost of any inconvenience, transportation damage, misuse, abuse, accident or similar incident.

SILENT KNIGHT GIVES NO WARRANTY, EXPRESS OR IMPLIED, OF MERCHANTABILITY, FITNESS FOR ANY PARTICULAR PURPOSE, OR OTHERWISE WHICH EXTENDS BEYOND THE DESCRIPTION ON THE FACE HEREOF. UNDER NO CIRCUMSTANCES SHALL SILENT KNIGHT BE LIABLE FOR ANY LOSS OF OR DAMAGE TO PROPERTY, DIRECT, INCIDENTAL OR CONSEQUENTIAL, ARISING OUT OF THE USE OF, OR INABILITY TO USE SILENT KNIGHT ALARM'S PRODUCTS. FURTHERMORE, SILENT KNIGHT SHALL NOT BE LIABLE FOR ANY PERSONAL INJURY OR DEATH WHICH MAY ARISE IN THE COURSE OF, OR AS A RESULT OF, PERSONAL, COMMERCIAL OR INDUSTRIAL USE OF ITS PRODUCTS

This warranty replaces all previous warranties and is the only warranty made by SILENT KNIGHT. No increase or alteration, written or verbal, of the obligation of this warranty is authorized.

"SILENT KNIGHT" is a registered trademark.



Model IFP-100 Basic Operating Instructions

These Instructions must be framed and displayed next to the IFP-100 panel in accordance with NFPA 72 fire code for Local Protected Fire Alarm Systems. Test the system in accordance to NFPA 72.

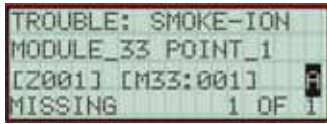
Operation	Task to Perform
Silence Alarms and Troubles	Press SILENCE then enter a code if prompted. Silence LED will light.
Reset Alarms	Press RESET then enter a code if prompted.
Acknowledge Alarms and Troubles	Press ACK then enter a code if prompted. When the Alarm or Trouble is acknowledged an  will appear in the annunciator display as shown Below. <div style="border: 1px solid black; padding: 5px; margin: 10px 0;">  </div>
View Alarms, Supervisories, and Troubles	For each type of condition press the ∇ or \triangle button associated for Alarms, Supervisories, or Troubles.
Conduct a Fire Drill	Press the DRILL button enter a code if prompted. or 1. Press ENTER to access Main Menu. 2. Then press 1 to select System Tests. 3. Enter code if prompted, then press 1 to select Fire Drill. 4. Press ENTER to start the fire drill. 5. Press ENTER to end the fire drill.
View a Point's Status	1. Press ENTER to access Main Menu. 2. Then press 2 to select Point Functions. 3. Enter code if prompted, then press 2 to select Point Status. 4. Select the module the device is located on by using the ∇ or \triangle . Then press ENTER . 5. Enter the point number.
Check Detector Sensitivity	1. Follow steps 1 through 5 for viewing a point status. 2. Press \triangleright to view detector sensitivity.
Set Time and Date	1. Press ENTER to access Main Menu. 2. Then press 4 to select Set Time & Date. Enter a code if prompted 3. Make changes in the fields on the screen as necessary. 4. Press ENTER if you wish to keep the changes. 5. Press ENTER to set the entered time and date.
Enable / Disable a Point	1. Press ENTER to access Main Menu, then rotate the key or enter a code if prompted. 2. Then press 2 to select Point Functions. 3. Enter code if prompted, then press 1 to select Disable / Enable Pt. 4. Select the module the point is located on by using the ∇ or \triangle . Then press ENTER . 5. Enter the point number.
View Event History	1. Press ENTER to access Main Menu. 2. Press 3 to select Event History. 3. Press the ∇ or \triangle to view events in the history buffer.
For Service call:	

Cut Along the Dotted Line

Cut Along the Dotted Line



7550 Meridian Circle, Ste 100
Maple Grove, MN 55369-4927
763-493-6455 or 800-328-0103
Fax: 763-493-6475
www.silentknight.com

© 2007 Honeywell International Inc.